

INSTRUCTION MANUAL

Serial Number _____

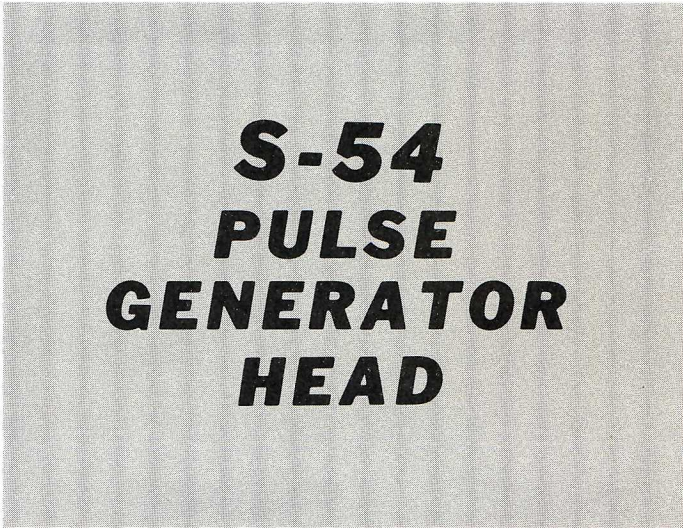

**S-54
PULSE
GENERATOR
HEAD**



WARRANTY

All Tektronix instruments are warranted against defective materials and workmanship for one year.

Any questions with respect to the warranty, mentioned above should be taken up with your Tektronix Field Engineer or Representative.

All requests for repairs and replacement parts should be directed to the Tektronix Field Office or representative in your area. This procedure will assure you the fastest possible service. Please include the instrument Type (or Part Number) and Serial or Model Number with all requests for parts or service.

Specifications and price change privileges reserved.

Copyright © 1970 by Tektronix, Inc., Beaverton, Oregon. Printed in the United States of America. All rights reserved. Contents of this publication may not be reproduced in any form without permission of the copyright owner.

U.S.A. and foreign Tektronix products covered by U.S. and foreign patents and/or patents pending.

TABLE OF CONTENTS

	Page		Page
SECTION 1 SPECIFICATION		SECTION 5 PERFORMANCE CHECK/CALIBRATION PROCEDURE	
General Information	1-1	Introduction	5-1
Electrical Characteristics	1-1	Equipment Required	5-1
Environmental Characteristics	1-2	Performance Check Procedure	5-1
Mechanical Characteristics	1-3	Calibration Procedure	5-6
SECTION 2 OPERATING INSTRUCTIONS		SECTION 6 ELECTRICAL PARTS LIST	
General Information	2-1	Abbreviations	
Installation		Parts Ordering Information	
General	2-1	Special Notes and Symbols	
Head Installation	2-1	Index	
Extender Cable Installation	2-1	Electrical Parts List	
First Time Operation		SECTION 7 DIAGRAMS	
Procedure	2-3	Symbols	
Lead Time	2-5	Component Locations	
SECTION 3 CIRCUIT DESCRIPTION		Troubleshooting Waveforms	
General Information	3-1	Diagram	
Block Diagram	3-1	SECTION 8 MECHANICAL PARTS LIST	
Circuit Description		Mechanical Parts Information	
Period Generator	3-2	Mechanical Parts List	
Trigger Output	3-2	Mechanical Parts Illustration	
Delay	3-3		
Duration	3-3	CHANGE INFORMATION	
Trigger Shaper	3-3		
Output	3-3	Abbreviations and symbols used in this manual are based on or taken directly from IEEE Standard 260 "Standard Symbols for Units", MIL-STD-12B and other standards of the electronics industry. Change information, if any, is located at the rear of this manual.	
SECTION 4 MAINTENANCE			
Introduction	4-1		
Obtaining Replacement Parts	4-1		
Parts Removal and Replacement	4-1		
Parts Locations	4-2		
Output Diode Replacement	4-2		

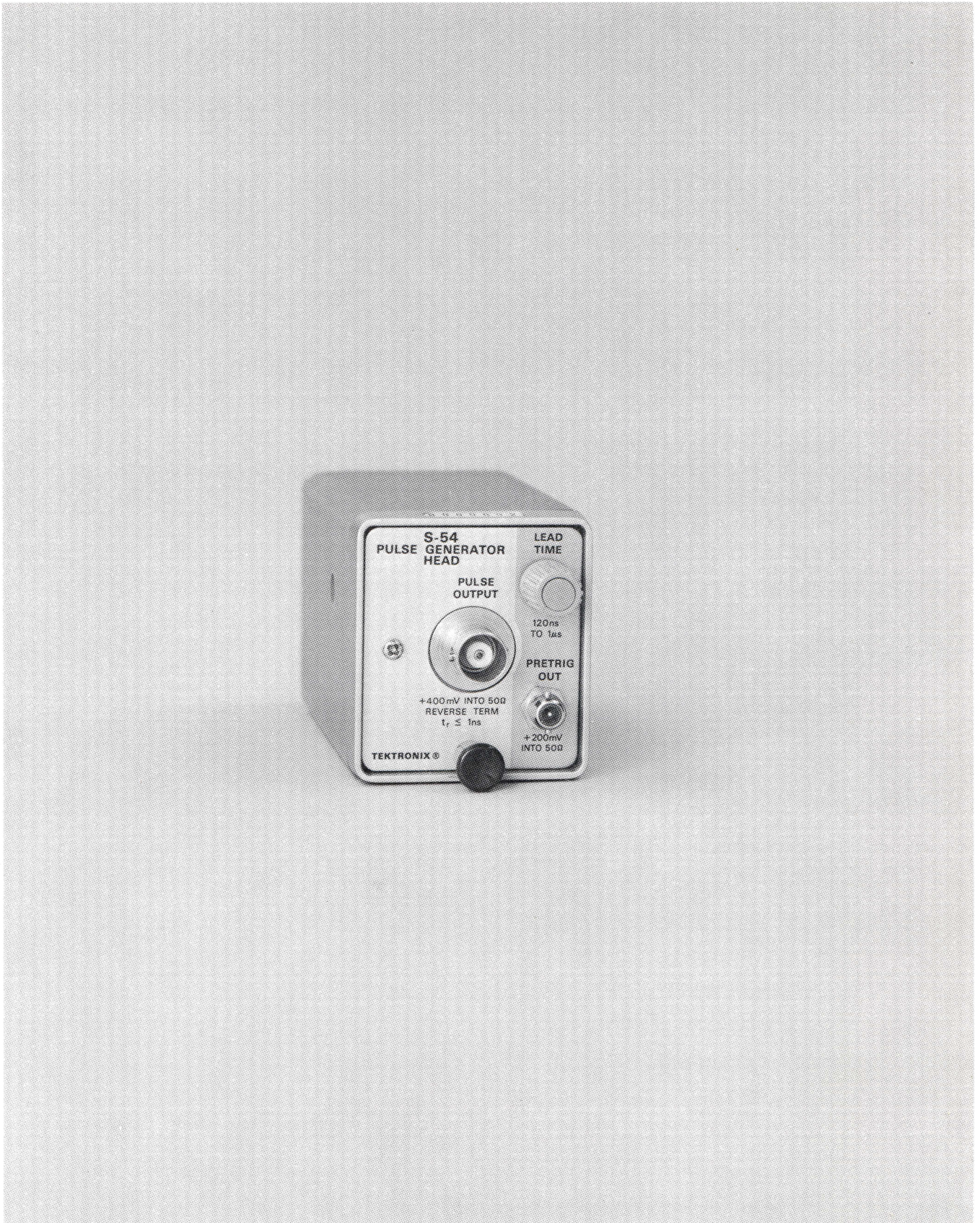

Fig. 1-1. S-54 Pulse Generator Head.

SECTION 1

SPECIFICATION

Change information, if any, affecting this section will be found at the rear of this manual.

General Information

The Type S-54 Pulse Generator Head provides a fast risetime pulse output for use with a sampling oscilloscope system. A variable lead time trigger and a positive pulse output signal at 50 Ω impedance makes the Type S-54 useful in a Time Domain Reflectometry (TDR) system.

A pretrigger output signal is available at the Type S-54 front and rear panels. The lead time can be controlled externally (for example, with the circuits in the 7S12 TDR unit), or by the Type S-54 front panel LEAD TIME control.

Operating power for the Type S-54 is obtained when the unit is installed into the sampling head compartment (or

connected via an interconnecting cable) in Tektronix sampling instruments such as 7S12, 7S11, Type 3S2, Type 3S5, or Type 3S6. The Type S-54 can also be powered from the Type 285 Power Supply.

Electrical Characteristics

The following characteristics apply over an ambient temperature range of 0°C to +50°C after a 10 minute warmup, for an instrument calibrated at a temperature between +20°C and +30°C. The required operating voltages are applied to the instrument when it is connected or installed into the sampling head compartment or powered by a sampling head power supply.

ELECTRICAL CHARACTERISTICS

Characteristic	Performance Requirement	Supplemental Information
PULSE OUTPUT		
Risetime into 50 Ω	1 ns or less	
Amplitude into 50 Ω	At least +400 mV	
Aberrations	+1.5%, -1.5%, total of 1.5% P-P (as displayed with Type S-1 Sampling Head in the sampling system)	
Pulse Duration	25 μ s, within 2 μ s	
Period	50 μ s, within 2.5 μ s	
Baseline Level		0 V within 20 mV, terminated in 50 Ω
Source Impedance		50 Ω within 5%
Pretrigger Out (Front or Rear Panel) (Front Panel connector unterminated when checking rear panel Pre-trigger Out)		
Amplitude into 50 Ω	at least +200 mV	

ELECTRICAL CHARACTERISTICS (cont)

Characteristic	Performance Requirement	Supplemental Information
Risetime into 50 Ω	5 ns or less	
Pulse Duration		20 ns or less at the 50% amplitude level
Pretrigger to Pulse Output time (LEAD TIME)	From 120 ns or less to 1 μ s or greater	
Pretrigger to Pulse Output jitter (Lead time jitter)	100 ps or less, at 120 ns pretrigger to output pulse time, increasing to 1 ns or less at 1 μ s pretrigger to output pulse time. (With 7S11, 7T11, and 7000-series Oscilloscope system, excluding sampling oscilloscope jitter)	

ENVIRONMENTAL CHARACTERISTICS

Characteristic	Performance Requirement	Supplemental Information
Temperature		
Non-operating		-40°C to +65°C
Operating		0°C to +40°C
Altitude		
Non-operating		To 50,000 feet
Operating		To 15,000 feet
Vibration (Non-operating)		15 minutes along each axis at 0.015 inch. Vary the frequency from 10 to 55 to 10 Hz in 1-minute sweeps. Three minutes at any resonant point or at 55 Hz.
Shock (Non-operating)		Two shocks each of 500 g's (2 ms duration), 750 g's (1 ms duration) and 1000 g's (0.5 ms duration), in each direction and along each major axis for a total of 36 shocks.
Transportation		Meets National Safe Transit Committee type of test when packaged as shipped by factory.

MECHANICAL CHARACTERISTICS

Characteristic	Description	
Finish	Anodized aluminum front panel, extruded aluminum blue-vinyl painted cabinet with aluminum castings front and rear.	
Weight	Approximately 8 oz.	
Dimensions		
Height	About 2 inches	
Width	About 1 3/4 inches	
Length	About 4 inches	

SECTION 2

OPERATING INSTRUCTIONS

Change information, if any, affecting this section will be found at the rear of this manual.

General Information

This section of the manual provides the basic information required for operation of the Type S-54 Pulse Generator Head, including installation and First Time Operation instructions.

The Type S-54 may be powered by any Tektronix instrument containing a sampling head compartment (Tektronix 7S12, 7S11, or Types 3S2, 3S5, 3S6, or 286). Or, the unit may be powered separately by a Tektronix Type 285 Power Supply for S-50 Series Heads. The Type S-54 may be connected to a head compartment by one of two accessory extender cables. This permits use of short-length coaxial cables between the PULSE OUTPUT connector and the load.

A variable lead time pretrigger, a fast pulse output at 50 Ω impedance, and compatibility with sampling instruments makes the Type S-54 useful for many Time Domain Reflectometry (TDR) measurements. When the Type S-54 is used in the 7S12 TDR Sampling Unit, the lead time is determined by the 7S12.

A pretrigger output pulse allows a sequential sampling system to display the main pulse without using a delay line in the signal path. The pretrigger pulse is available at both the front and rear panel connectors.

INSTALLATION

General

Since the Type S-54 Pulse Generator Head can be powered by Tektronix instruments containing sampling compartments or sampling head extender cables, many combinations of instruments are possible. Three general methods of installation are shown in Fig. 2-1. Part (A) shows the Type S-54 installed in the pulse generator compartment of the Tektronix 7S12 TDR Sampling Unit. The 7S12 can be used in any 7000-series oscilloscope. Part (B) shows the Type S-54 installed in the Channel B compartment of the Type 3S2 Sampling Unit. This leaves Channel A of the sampling unit available to operate a sampling head. Part (C) shows the Type S-54 installed in the head compartment of the Type 285 Power Supply.

With (A), (B), or (C) method of installation, the Type S-54 can be plugged into the sampling unit or power supply as shown, or used remotely on a special extender cable. Three and six foot extender cables are available. Order the three foot extender cable by Tektronix Part No. 012-0124-00, or the six foot extender cable by Tektronix Part No. 012-0125-00. Contact your local Tektronix Field Office or representative for price and availability of these optional accessories.

Head Installation

To insert the Type S-54 into a compartment of the sampling unit or power supply, proceed as follows:

1. Pull the latch knob outward from the front panel (the latch knob will push out normally when the unit is inserted if the knob is left free to move).
2. Insert the unit slowly into the compartment, so the two plastic guides enter the rear connector opening.
3. Push the Type S-54 completely into the compartment.
4. Push the latch knob to lock the unit in place.

To remove the S-54 from the compartment, pull the latch knob away from the front panel, then pull the unit from the compartment.

Extender Cable Installation

To use the Type S-54 on an extender cable, install as follows:

1. Pull the latch knob located on the head end of the extender cable outward from its panel (the latch knob will push out normally when the extender is inserted if the knob is free to move).
2. Insert the extender cable head end slowly into the desired compartment in the sampling unit so the plastic guides engage the unit.

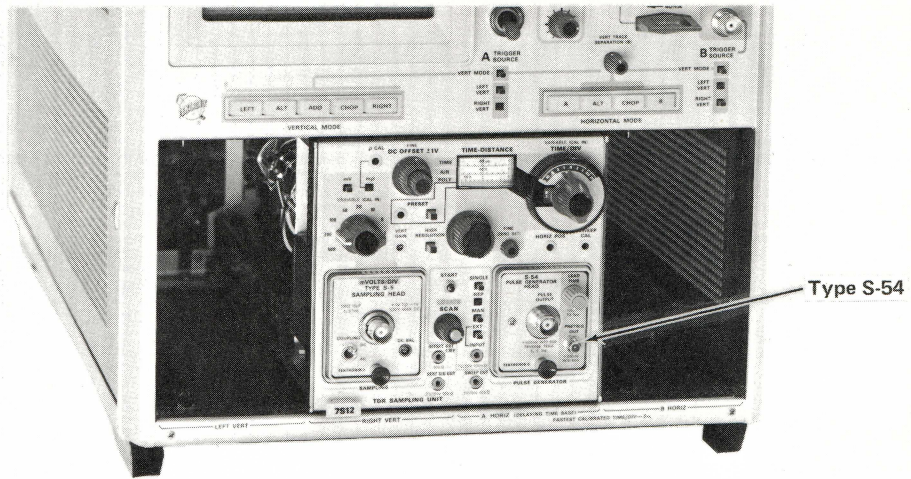

(A) Installed in a Pulse Generator Compartment

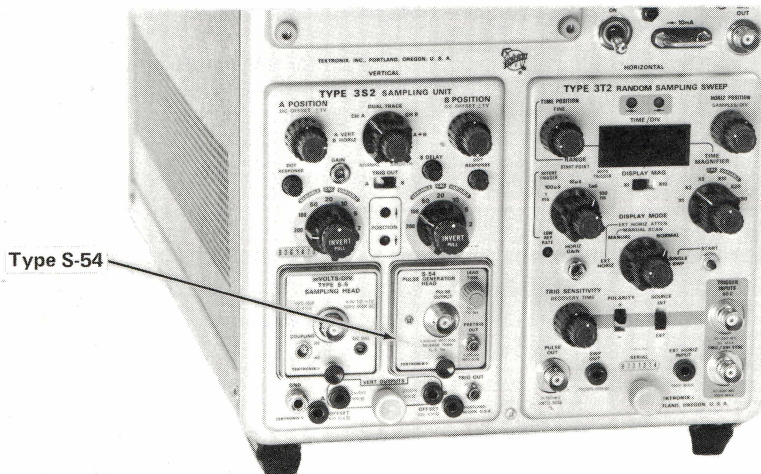

(B) Installed in a Type 3S2 Sampling Head Compartment

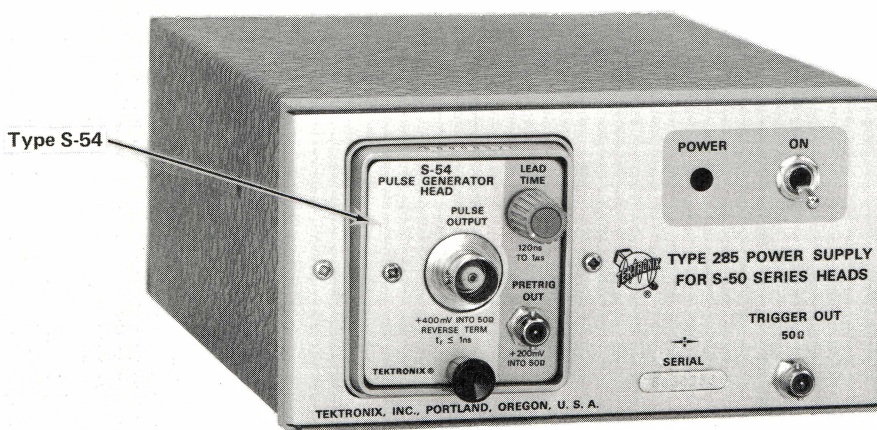

(C) Installed in Type 285 Power Supply Compartment

Fig. 2-1. S-54 Installation Information.

3. Push the head completely into the compartment.
4. Push the latch knob to lock the extender cable head end in place.
5. Connect the Type S-54 to the other end of the extender cable in a similar manner, and set the latch knob to hold it in place.
6. To remove the Type S-54 from the extender cable, pull the latch knob on the front panel of the Type S-54, and remove the unit from the extender cable.
7. To remove the extender cable head from the sampling unit compartment, pull the latch knob outward from the front of the panel, then pull the extender cable free.

To install the Type S-54 in the Type 285 Power Supply or on an extender cable attached to the Power Supply, use the procedure above. Powering the Type S-54 with the Type 285 Power Supply allows both channels of a dual-trace sampling unit (such as Type 3S2) to be used for sampling heads.

When the Type S-54 is used with the 7S12, the LEAD TIME control is inoperable.

Three controls, normally adjusted during calibration, are available through holes in the Type S-54 case. They include the Duration Trigger Level (R30) on the left side, Q50 Bias (R50) at the upper right side, and C64 at the center right side. Refer to the Calibration Procedure in Section 5 for information about these controls.

FIRST TIME OPERATION

Substitute equipment for the First Time Operation may include any Tektronix Type 560 Series Oscilloscope with a 3S-series dual trace sampling unit containing one sampling head, and a 3T-series sampling time base unit. This First Time Operation uses the Type 564 with Types 3T2, 3S6, S-5 and S-54 as shown in Fig. 2-1B. If you are using equipment as shown in Fig. 2-1A, follow the First Time Operation information given in the 7S12 instruction manual.

Procedure

1. With the Type 564 Power switch off, insert a Tektronix Type 3S2 Sampling Unit into the vertical compartment (left) and a Tektronix Type 3T2 Random Sampling Sweep into the horizontal plug-in compartment.

2. Insert the Type S-5 into Channel A (left) of the Type 3S2, leaving the latch free to move. Once the Type S-5 is seated, push the latch to lock it in place.

3. Insert the Type S-54 into Channel B (right) of the Type 3S2, leaving the latch free to move. Once the Type S-54 is seated, push the latch to lock it in place.

4. Install a BNC tee connector onto the Type S-5 input connector.

5. Connect the Type S-54 PULSE OUTPUT to one arm of the tee connector, using the short 50 Ω coaxial cable supplied with the Type S-54. Terminate the other arm of the tee connector in 50 Ω.

6. Connect the Type S-54 PRETRIG OUT to the 50 Ω Trigger Input of the Type 3T2, using a BSM to BNC 50 Ω coaxial cable (Tektronix Part No. 012-0128-00, 10 inch length).

7. Set the Type 564 Intensity control fully counter-clockwise.

8. Connect the Type 564 to the power line and set the Power switch to On.

9. Set the instrument controls as follows:

	Type S-54
LEAD TIME	Fully CCW
	Type S-5
Coupling	DC
	Type 564
Upper and Lower Screen	Non-store
	Type 3S2
Display Mode	CH A
Normal-Smooth	Normal
Horiz Plug-In Compatibility (behind front panel)	Sampling, 3T-Series
Channel A controls	
Position	Midrange
DC Offset	Midrange (5 turns from one end)
Units/Div	200

Operating Instructions—S-54

Variable	Cal
Invert	Pushed In
Dot Response	Midrange
Channel B controls	Optional

Type 3T2

Time Position	Fully Clockwise	
Horiz Position	Midrange	
Samples/Div (behind rear panel)	Variable	
Samples/Div	9 o'clock position	
Display Mode	Normal	
Start Point	With Trigger	
Range	100 ns	
Display Mag	X1	
Time Magnifier	X1	10 ns/div
Variable	Cal	
Trigger Source	Ext	
Trigger Sensitivity	Fully Clockwise	
Recovery Time	Centered	
Trig Polarity	(+)	

10. After a five minute warmup, set the Type 564 Intensity control for normal trace brilliance. Adjust Astigmatism and Focus controls for best focus.

11. Center the trace on the graticule with the Type 3S2 DC Offset control.

12. Adjust the Type 3T2 Trigger Sensitivity control for a stable triggered display of the Type S-54 output pulse leading edge (about 0.5 V amplitude). Use the Time Position control to position the leading edge to the left side of the display. Use the Type 3S2 DC Offset control to position the top of the pulse at the graticule centerline. See Fig. 2-2.

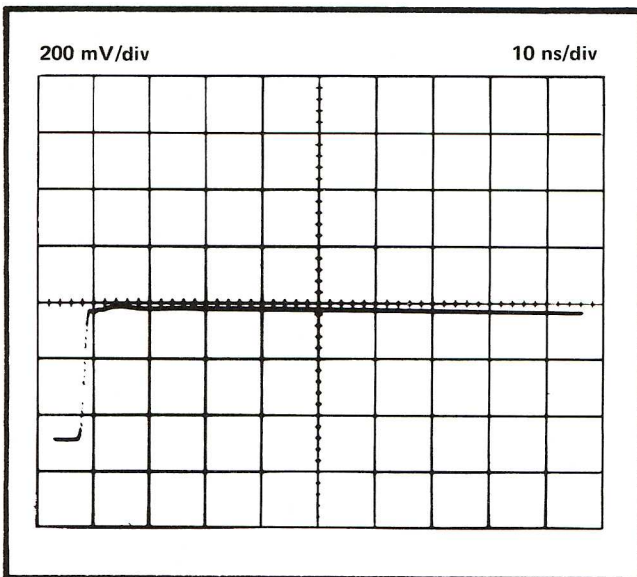

Fig. 2-2. PULSE OUTPUT leading edge (50 Ω termination).

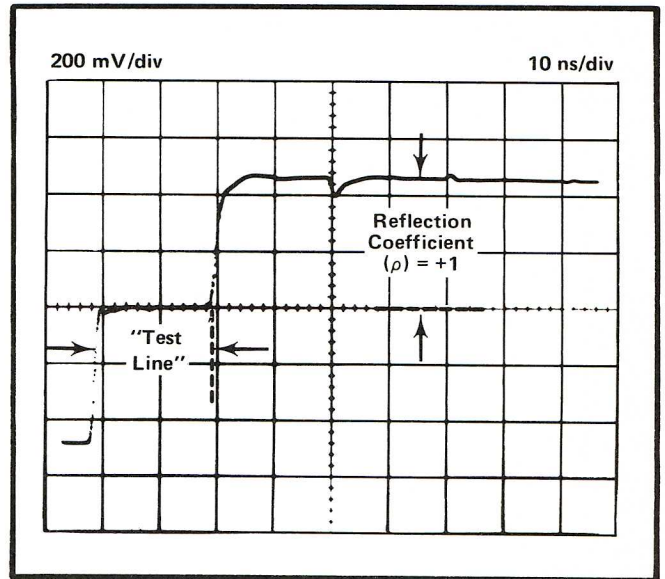

Fig. 2-3. Display with unterminated Test Line.

13. Remove the 50 Ω termination from the tee connector and note that pulse amplitude increases about two times.

14. Add a short length of 50 Ω coaxial cable to the tee connector. (Example uses two 42 inch coaxial cables for a total of about 84 inches in length.) See Fig. 2-3. The open line shows a reflection coefficient (rho) of about +1.

15. Terminate the end of the Test Line in 50 Ω. Change the Type 3S2 mV/Div to 20 and note the point of termination on the display. See Fig. 2-4.

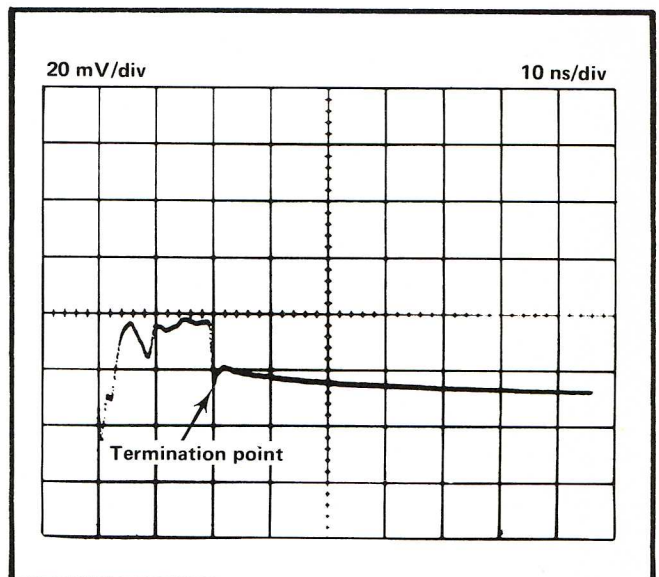

Fig. 2-4. Display with Test Line terminated and increased vertical deflection of the oscilloscope.

16. Remove the 50 Ω termination and add about 100 feet of additional cable. Change the Type 3S2 Channel A mV/Div to 200. Change the Type 3T2 Time/Div Range to 1 μ s and the Time Magnifier to X2.

17. Adjust the Type S-54 LEAD TIME control to position the desired time window on the CRT as shown in Fig. 2-5.

Lead Time

The LEAD TIME control sets the time between the Pre-trigger Out pulse and the PULSE OUTPUT. This LEAD TIME control along with the Type 3T2 Time Position controls allows the start of the time window on the CRT to be set over the operating range. Use the DC Offset and the mV/div controls on the Type 3S2 to obtain the desired vertical deflection factor and offset voltage. The Type S-54 is useful for analyzing reflections in lengths of coaxial cable to over 3000 feet. For basic principles and measurement information about TDR displays, read Tektronix Measurement Concepts Series booklet "Time Domain Reflectometry Measurements", Tektronix Part No. 062-1244-00.

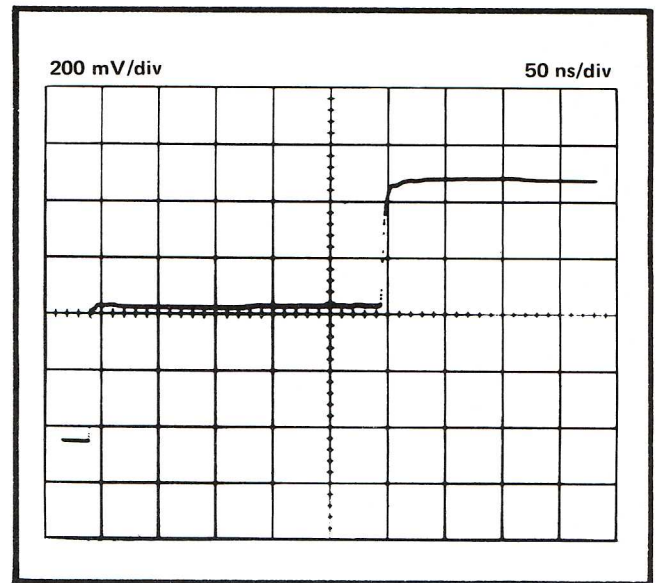

Fig. 2-5. Display showing unterminated coaxial line (about 100 feet).

Using the Type S-54 in the 7S12 TDR Unit, the lead time is calibrated in the 7S12 for time and distance.

SECTION 3

CIRCUIT DESCRIPTION

Change information, if any, affecting this section will be found at the rear of this manual.

General Information

This section of the manual contains the electrical description of the Type S-54 Pulse Generator Head circuits.

The Type S-54 requires +15 V and -12.2 V input power. The input power is obtained when the instrument is connected to the pulse generator compartment connector of a TDR Sampling Unit, to one compartment connector of a dual-trace sampling unit, or to the Type 285 Power Supply.

Refer to the schematic diagram in Section 7 as necessary during the Circuit Description.

BLOCK DIAGRAM

The Block diagram, Fig. 3-1, shows the major circuit blocks of the Type S-54. A partial block diagram, Fig. 3-2, shows the function of the Type S-54 when it is used with the 7S12 TDR Sampling Unit. A brief description of each block follows, starting with the Period Generator block.

The Period Generator contains a free running multivibrator with a period of about 50 μ s. The positive output excursion of the Period Generator drives the Trigger and the Delay circuits.

The Trigger circuit, when driven by the Period Generator, provides two positive trigger output signals. One trigger

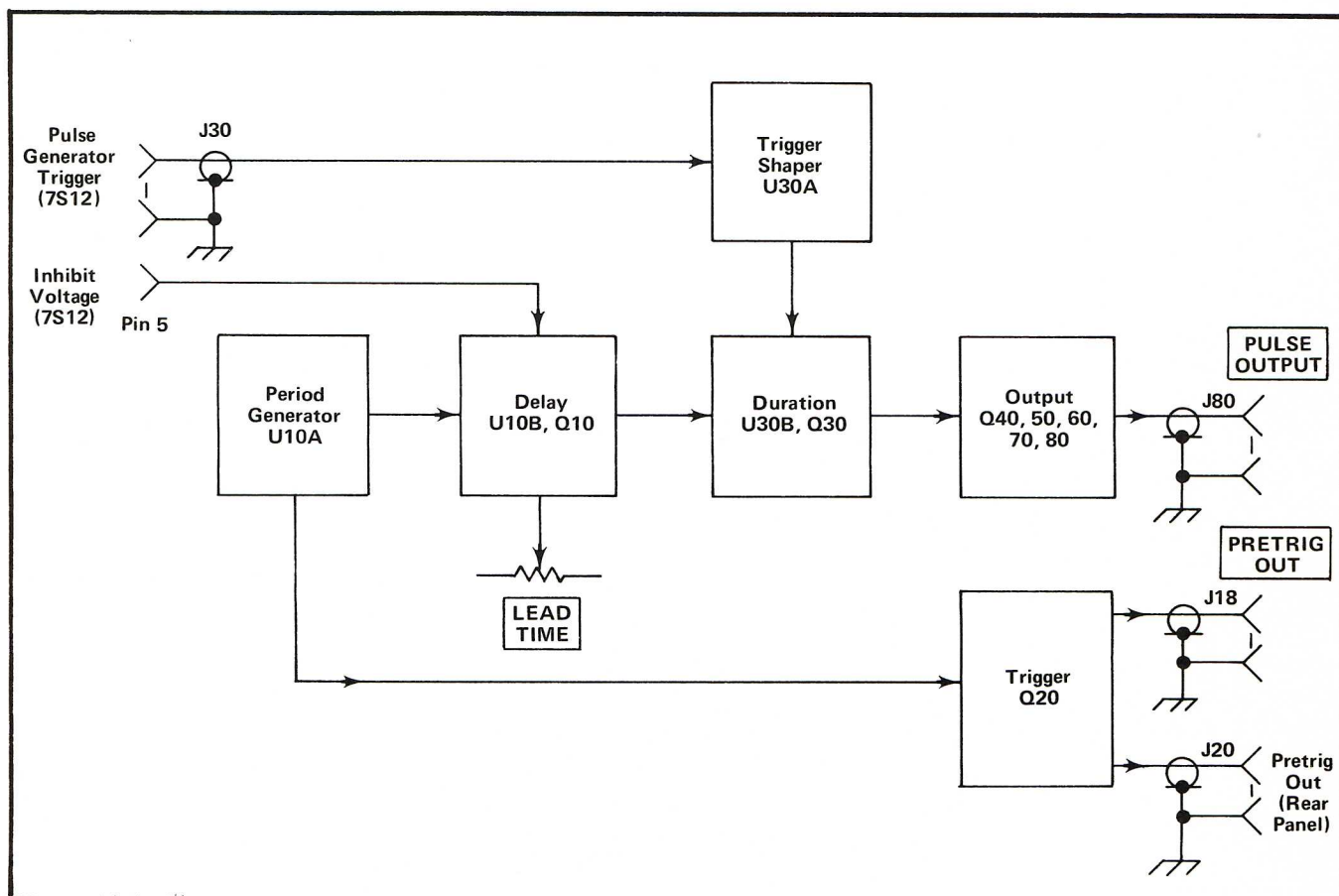

Fig. 3-1. S-54 Block Diagram.

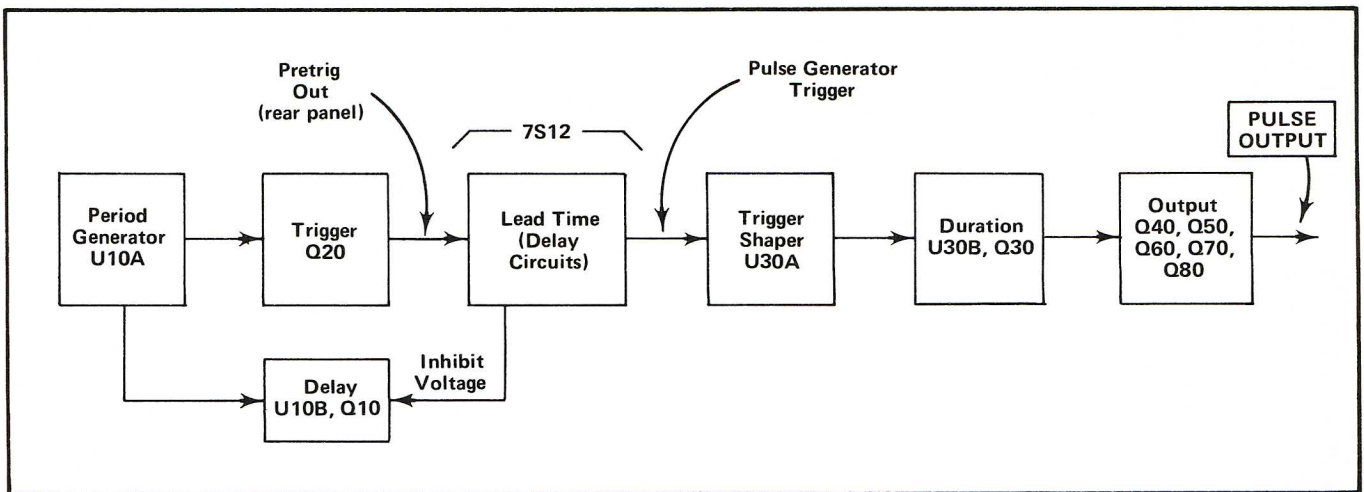

Fig. 3-2. Partial block diagram showing the function of the S-54 when used with the 7S12 TDR Sampling Unit.

signal is connected to the front panel PRETRIG OUT connector, and one to the rear coaxial connector that mates with the sampling head compartment coaxial connector.

In the absence of an external Inhibit Voltage, the Delay circuit is triggered by the positive pulse from the Period Generator and provides a delayed output pulse to drive the Duration circuitry. The range of delay time (120 ns to 1 μ s or more) can be set by the front panel LEAD TIME control.

If the Type S-54 is used with a 7S12, an external Inhibit Voltage is provided to the Delay. This voltage inhibits the Delay so that the circuits in the 7S12 can provide the delay function. The 7S12 then provides a Pulse Generator Trigger signal that is delayed from the trigger output signal of the Type S-54. This Pulse Generator Trigger signal drives the Trigger Shaper, which drives the Duration circuit.

The Duration is driven from either the Delay or the Trigger Shaper, and generates a positive output pulse of about 25 μ s duration to drive the Output.

The Output shapes or speeds up the risetime of the 25 μ s pulse from the Duration to provide the positive 25 μ s output pulse. The output appears as a 50 Ω voltage source at an amplitude of at least 800 mV. This produces at least 400 mV amplitude pulse across a 50 Ω load with a risetime equal to or less than 1 ns.

CIRCUIT DESCRIPTION

Period Generator

The Period Generator circuit determines the frequency of operation of the Type S-54. The frequency of the Period Generator, a free running multivibrator, depends upon the value of C7, R6, and variable R5.

U10A pins 2, 3, and 4 are connected to -12.2 volts and are held low. When pin 1 is low, all inputs to U10A are low, which sets U10A output pin 6 low and pin 5 high. With pin 6 low and pin 5 high, C7 charges through feedback resistors R6 and R5 until the voltage at pin 1 crosses from a low to a high state. U10A outputs then switch states, and the capacitor discharges through the feedback resistors until a cross-over voltage is again reached, which switches the multivibrator. The period of oscillation is about 50 μ s, set by R5 during calibration. The positive signal output of the Period Generator, at U10A pin 5, drives the Trigger circuit and the Delay circuit.

Trigger Output

The Trigger Output circuit consists of Q20, T18, T20 and associated components.

With U10A pin 5 (Period Generator) low, Q20 is nearly cut off and C22 is discharged through R22. When U10A pin 5 goes high, this high signal is connected to Q20 base through CR20, turning Q20 on full. Q20 then charges C22 with current pulses through the primary of T18 and T20, resulting in a positive output signal to front-panel PRETRIG OUT connector J18, and rear-panel coaxial connector J20. C24 and R24 in T20 secondary circuit shapes the trigger signal to J20.

Delay

The Delay circuit consists of U10B, Q10, T15, and associated components.

In the absence of an external Inhibit Voltage, and when driven by the positive pulse from the Period Generator, the Delay circuit provides a delayed pulse output to drive the Duration circuit. The delay time is controlled by the front-panel LEAD TIME control.

In the absence of the Inhibit Voltage and the positive signal from the Period Generator, U10B pins 10, 11, 12, and 13 are low. This results in a high at pin 9 and a low at pin 8. With a high at pin 9, C12 is charged with current from U10B. This sets Q10 base high through CR12, and Q10 is cut off. Quiescent bias at T15 secondary to U30B pin 12 is held low by R33, R32, and R30. R30 allows this bias to be set during calibration.

When U10A pin 5 (in the Period Generator) goes high, a positive trigger input signal through C10 is coupled to U10B pin 10, causing U10B pin 8 to go high, coupling the high through C14 and R14 to pin 11, clamping pin 8 high. When pin 10 moves high, pin 9 allows C12 to discharge through CR12, R9, R10, and the front-panel LEAD TIME control R15, until Q10 starts to conduct. When Q10 conducts, U10B pin 11 goes low. All U10B input pins are low, so U10B output pin 8 goes low and pin 9 high. When pin 8 goes low, T15 couples a positive pulse to the Duration circuit at U30B pin 12. When pin 9 goes high, C12 charges through U10B. This sets Q10 base high through CR12, and Q10 is cut off. Pin 11 is held low by a low at pin 8 and R14. The circuit is ready for another positive trigger from the Period Generator, unless an external inhibit voltage is connected to CR10 anode.

If an external Inhibit Voltage is connected to CR10 anode, CR10 conducts, connecting a high to U10B pin 13. The high at pin 13 changes and holds the output constant with a high at pin 8 and a low at pin 9. As long as the Inhibit Voltage is connected to CR10 anode, the Delay circuit will be inhibited.

Duration

The Duration circuit consists of U30B, Q30, and associated components. When the circuit is driven by a positive pulse from either the Delay circuit or the Trigger Shaper circuit, the Duration circuit produces about a 25 μ s positive pulse to drive the Output circuit. The positive pulse output duration is set by R35 during calibration.

In the absence of a positive pulse at either U30B pin 10 or pin 12, U30B pins 10, 11, 12, and 13 are all held low.

With a low on all inputs, U30B output pin 8 is low and pin 9 is high. The low at pin 8 allows pin 11 to be held low by R36. With a high at pin 9, C30 is charged with the current from U30B. This sets Q30 base high through CR30, and Q30 is cut off.

When a positive pulse signal is received at U30B pin 12 from the Delay circuit, U30B outputs change states, with pin 8 going high and pin 9 attempts to go low. (The circuit operates in the same manner with a positive pulse to pin 10 from the Trigger Shaper circuit.) When pin 8 goes high, it starts the output drive pulse to the Output circuit. Also when pin 8 goes high, a high is connected by R36 to pin 11, which clamps pin 8 in the high state. As pin 9 attempts to go low, it allows C30 to start to discharge through CR30, R34, and R35. C30 discharge produces a negative ramp voltage to the base of Q30, causing Q30 to conduct. When Q30 conducts, U30B pin 11 goes low. When pin 11 goes low, all U30B input pins are low (pin 10 and pin 12 are low in the absence of positive input signals). The output of U30B pin 8 then goes low, and pin 9 goes high.

When pin 8 goes low, it terminates the positive output drive pulse to the output circuit. When pin 9 goes high, C30 charges with current from U30B. This sets Q30 base high through CR30 and turns off Q30. The low at pin 8 holds pin 11 low through R36. The circuit is ready for the next positive trigger pulse from the Delay circuit.

Trigger Shaper

The Trigger Shaper circuit consisting of U30A and associated components, must be driven by an external positive pulse such as the Pulse Generator Trigger pulse from the 7S12 TDR Sampling Unit. The circuit output pulse drives the Duration circuit.

Before the arrival of the Pulse Generator Trigger pulse, a negative current from the 7S12 forward biases the snap off diode CR26. U30A input pins are all low resulting in a low output at pin 6. When the next Pulse Generator Trigger signal, a positive signal, arrives at J30, it reverse biases CR26 and causes a fast pulse to be coupled through C26 and R27 to U30A pin 4. With pin 4 high, U30A output pin 6 goes high connecting this high to U30B pin 10 in the Duration circuit.

Output

The Output circuit consists of Q40, Q50, Q60, Q70, Q80, and associated circuit components. The input signal is direct coupled from the Duration circuit (U30B pin 8), and the circuit output is connected to the front-panel PULSE OUTPUT connector. The circuit shapes or speeds up the rise and fall time of the input pulse to control connecting diodes to the output.

Circuit Description--S-54

The positive pulse from the Duration circuit is connected to Q40 base in the emitter-coupled current mode switch circuit Q40-Q50. During calibration, Q50 base is set to a voltage which corresponds to the mid-point of the positive and negative excursions of the input signal. The output of Q40-Q50 circuit is directly connected to another current mode switch circuit, Q60-Q70, which drives Q80. In the absence of an input pulse, the quiescent current path from the +15 V supply through R83, CR80, Q80, R64, Q60, R61, R60 to the -12.2 V supply, reverse biases CR82, which prevents current in R87, R88 and any external circuit. This causes the output voltage to be zero. CR84 conducts to hold its cathode at about -0.6 V, and keeps Q80 out of saturation.

When the input moves positive, current through Q40 decreases. Q50 draws more current, and Q60 is cut off. Q70 conducts hard, due to the increased base drive from Q50 and the negative signal from the emitter of Q60. Q70 and Q60 couple signals to rapidly cut off Q80. The collector of

Q80 rises to a point determined by R86-R84, reverse-biasing CR80 and disconnecting Q80 from the output circuit. CR82 conduction causes a pulse to be developed across R87, R88, and the load for the time determined by the Duration circuit.

When the input signal goes low (back to the quiescent conditions), the current mode switch circuits cause Q80 to conduct, which cuts off CR82 as previously described. This terminates the output pulse to the PULSE OUTPUT connector.

C64 allows adjustment of capacitance associated with Q60, Q70, and Q80. C84, a wire capacitor, is used as a divider capacitor, and is adjusted only if the diodes CR80, CR82, and CR84 are replaced. Both adjustments should be made while examining the risetime and the front corner of the pulse output display.

SECTION 4

MAINTENANCE

Change information, if any, affecting this section will be found at the rear of this manual.

Introduction

This section of the manual is a maintenance guide for the Type S-54 Pulse Generator Head. Information is included for parts ordering, parts removal and replacement, disassembly and assembly.

Obtaining Replacement Parts

All parts used in the Type S-54 can be purchased directly through your local Tektronix Field Office or representative. However, replacements for standard electronic items can be obtained locally. Consult the Electrical or Mechanical Parts List to determine the value, tolerance and rating required.

NOTE

When selecting replacement parts, it is important to remember that the physical size and shape of a component may affect its performance at high frequencies. After repair, the Type S-54 Pulse Generator Head may require re-calibration.

Parts Removal and Replacement

Housing and Rear Panel. To remove the Type S-54 from its housing, loosen the four retaining screws on the rear panel. Slide the rear panel off, and remove the housing by sliding it to the rear. With the housing and rear panel removed, the unit can be connected to an extender cable for access to adjustment controls and circuit test points for calibration. Two lengths of extender cables are available from your local Tektronix Field Office or representative. Order by Tektronix Part No. 012-0124-00 for the three-foot length and Tektronix Part No. 012-0125-00 for the six-foot length extender cable.

To install the Type S-54 in its housing, align the hole closest to the front so that it will appear on the left side of the unit. Check that the upper and lower corners of the Timing board are aligned with the channels in the housing which contain the zigzag springs. Push the Type S-54 gently into the housing until it contacts the front panel. Be sure that the white plastic pawl in the locking knob is properly aligned as the Type S-54 is slid into the housing. Attach the rear casting, making sure that the hole on one side fits over the pretrigger signal output connector. Insert the four long

mounting bolts and tighten them securely. To ensure that the mounting bolts align with the front panel, hold the Type S-54 in its normal horizontal position; start the lower bolts, then turn the Type S-54 over and start the remaining two bolts.

Circuit Boards. To remove the Timing board, free the Pretrigger Out coaxial cable from the plastic hold down clamp, and gently pull the board outward from the Output board. This allows access to both sides of both boards. To remove the trigger coaxial lead from the front panel, use a 5/16-inch end wrench to hold the nut located behind the front panel. Then use a 9/32-inch end wrench to remove the coaxial cable retaining nut. Once this nut is removed, gently pull the coaxial cable, together with the connector center pin, from the connector. Remove the connector shell, by first loosening the nut located behind the front panel with the 5/16-inch end wrench. To install the Timing board reverse the procedure. (When inserting the coaxial cable, be sure that the outer braid is not shorted to the center conductor).

To remove the Output board, two resistors and a diode must be unsoldered from the center conductor of the PULSE OUTPUT connector.

Use the following procedure:

1. To remove the diode, heat sink the diode with a small-nose pliers or forceps and carefully unsolder the diode from the center conductor of the BNC connector.
2. Heat sink the two resistors and unsolder them from the center conductor of the BNC connector.
3. With a 5/64-inch allen wrench, remove the two screws holding the Output board to the BNC connector assembly. Remove the Output board from the connector.
4. Unsolder the cable from LEAD TIME potentiometer R15, freeing the Output board.
5. To install the Output board, reverse the procedure. Be sure the two spiral pins are flush with the connector holder before tightening the 5/16 inch allen screws.

Parts Locations

Photos of the Timing and Output boards, with the component locations, are shown in Section 7. The Mechanical Parts Illustration in Section 8 shows locations of the mechanical parts.

Output Diode Replacement

Output diodes CR80, CR82, and CR84 are soldered into the circuit using extremely short connecting leads. Care must be taken when soldering these diodes into place to prevent overheating the diodes. Since a heat sink is ineffective due to the short connecting leads, use a small soldering iron and minimum soldering time.

SECTION 5

PERFORMANCE CHECK CALIBRATION

Change information, if any, affecting this section will be found at the rear of this manual.

Introduction

This section of the manual contains the Performance Check and the Calibration Procedure. When the Performance Check Procedure is completed, the instrument is checked to the "Performance" information given in Section 1. The tolerances and waveforms given in the Calibration Procedure should be considered only as calibration guides, and not as instrument specifications.

Equipment Required

The following test equipment, or its equivalent is required for both the Performance Check Procedure and the Calibration Procedure of the Type S-54. All test equipment must be calibrated. If other equipment is substituted, it must meet or exceed the limits stated in the equipment list.

1. Oscilloscope; 7000-Series such as 7704 or 7504, to accept plug-in units listed in item 2.

2. Real Time plug-in units; 7A12 Dual-Channel Amplifier and 7B50 Time Base. Sampling plug-in units; 7S11 Sampling Amplifier with Type S-1 Sampling Head, and 7T11 Sampling Time Base.

NOTE

Substitute equipment for items 1 and 2:

(A) For real time requirement, dual-trace amplifier; minimum deflection factor 50 mV/div, risetime 25 ns or less. Oscilloscope such as the Type 547 with Type 1A1 Dual-Trace Amplifier.

(B) For sampling requirement, Vertical Sampling plug-in which will accept Type S-1 Sampling Head, with a compatible Time Base Unit with Random Sampling capability. Oscilloscope such as Type 561 or 564 with plug-in units such as Type 3S2, 3S5 or 3S6 with Type S-1 Sampling Head, and Time Base unit such as Type 3T2.

3. Type 285 Power Supply For S-50 Series Heads. The supply is a convenient power source and trigger out connection.

4. 10X Probe, P6012, Tektronix Part No. 010-0203-00.

5. Two 50 Ω coaxial cables (18 inch) BSM Female to BNC Male Tektronix Part No. 012-0127-00.

6. Three 50 Ω feedthrough terminations, BNC, Tektronix Part No. 011-0049-01.

7. 50 Ω coaxial cable (18 inch), BNC. Tektronix Part No. 012-0076-00.

8. Sampling-Head extender, 3 foot. Tektronix Part No. 012-0124-00.

9. Adapter, 3 mm Male to BNC Female. Tektronix Part No. 015-1018-00, supplied with 7T11.

PERFORMANCE CHECK PROCEDURE

Introduction

The Performance Check provides a means of rapidly checking the Type S-54 without adjusting any internal controls. Failure to meet any of the requirements given in this procedure indicates a need for internal checks or adjustments, and the user should refer to the Calibration Procedure in this section.

Preliminary Procedure

The first three steps use the Test Oscilloscope equipment list (item 1) with a dual-channel amplifier and time base (7A12 and 7B50 of item 2), and Type 285 Power Supply (item 3). Steps 4 through 7 use the Test Oscilloscope (item 1), with a sampling amplifier and Time Base (7S11 with Type S-1 and 7T11 of item 2), and Type 285 Power Supply (item 3).

1. Install the Type S-54 in the Type 285 Power Supply.

2. Set the controls as follows:

7504 Indicator Oscilloscope

A Intensity	CCW
B Intensity	CCW
Vertical Mode	Left
Horizontal Mode	B
A Trigger Source	Right Vert
B Trigger Source	Left Vert

7A12

(Left vertical plug-in compartment)

Display Mode	Alt
Trigger Source	CH 1
	CH 1 & CH 2
Volts/Div	.2 Volts/Div
Position	Midrange
Polarity	+Up
Variable	Cal In
Coupling	DC

(7B50)

(B horizontal plug-in compartment)

Level/Slope	Centered on Positive Slope
Triggering Mode	Auto
Coupling Source	AC
Position	Ext
Time/Div	Midrange
Display Mode	.05 μ s
Magnifier	Time Base
	X1

S-54

LEAD TIME Fully Counterclockwise

3. Turn the Type 285 and the Oscilloscope power on. After about a five minute warmup time, advance the B intensity until a free-running trace is observed. Center the traces on the CRT with the horizontal and vertical position controls.

Procedure

1. Check PRETRIG OUT to PULSE OUTPUT time

a. Connect the Type S-54 PULSE OUTPUT through a BNC 50 Ω coaxial cable, and a 50 Ω feedthrough termination to 7A12 CH 2. Connect the Type S-54 PRETRIG OUT through a BSM to BNC 50 Ω coaxial cable, and a 50 Ω feedthrough termination to 7A12 CH 1. Connect the Trigger Out 50 Ω connector on the Type 285 through a BSM to BNC 50 Ω coaxial cable, and a 50 Ω feedthrough termination to the 7B50 Ext Trigger In or Ext Volts In connector.

b. Change the 7B50 Triggering Mode to Normal and set the Level/Slope for a stable display (see Fig. 5-1A).

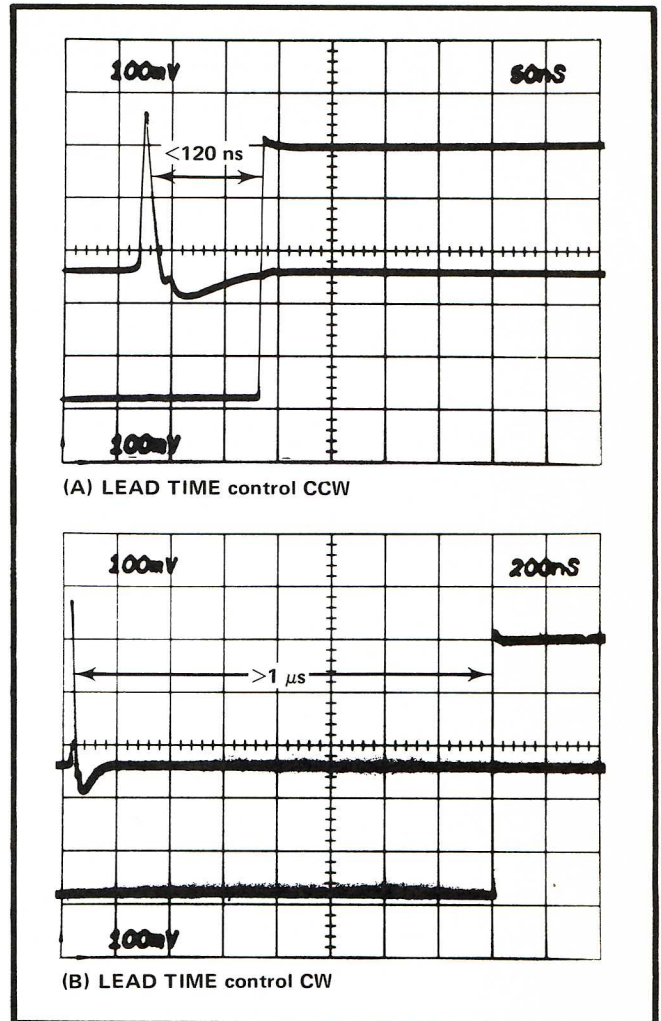

Fig. 5-1. PRETRIG OUT to PULSE OUTPUT time.

c. Observe that the time between the leading edge (50% amplitude point) of the PRETRIG OUT and the leading edge of the PULSE OUT is less than 120 ns.

d. Change the 7B50 Time/Div to .2 μ s. Turn the Type S-54 LEAD TIME control fully clockwise. Observe that the time between the PRETRIG OUT and the leading edge of the PULSE OUT is more than 1 μ s (see Fig. 5-1B).

2. Check PULSE OUTPUT Period and Duration

a. Change the 7B50 Time/Div to 5 μ s. Observe Channel 1 signal.

b. Check that the PULSE OUTPUT period is 50 μ s within 2.5 μ s (see Fig. 5-2).

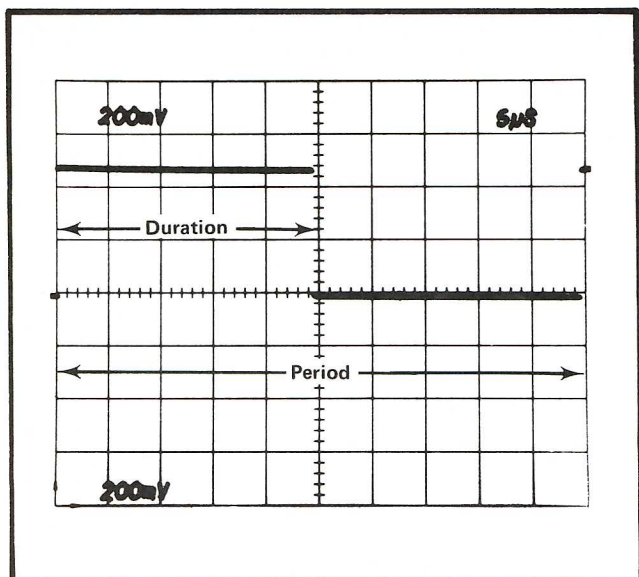

Fig. 5-2. PULSE OUTPUT period and Duration.

c. Check that the PULSE OUTPUT duration is 25 μ s within 2 μ s.

3. Check PULSE OUTPUT Amplitude

a. The equipment setup remains as in step 2. Check the PULSE OUTPUT amplitude to be at least 400 mV.

4. Check PULSE OUTPUT Risetime

a. Set the Sampling Oscilloscope controls as follows:

7504 Indicator Oscilloscope

A Intensity	CCW
B Intensity	CCW
Vertical Mode	Right
Horizontal Mode	A
A Trigger Source	Right Vert
B Trigger Source	Left Vert

**7S11 with Type S-1
(Right Vertical plug-in compartment)**

Delay	Midrange
+Up	Pushed in
DC Offset \pm 1 V and Fine	Midrange
mVolts/Div	100
Variable	Pushed in
Dot Response	Midrange
Normal	Pushed in

**7T11
(A horizontal plug-in compartment)**

Time Position and Fine	Fully clockwise
Sequential	Pushed in
Sweep Range	50 ns

Time/Div	5 ns
Variable	Pushed in
Scan	Midrange
Rep	Pushed in
Slope +	Pushed in
Trig Level	Midrange
Stability	Fully clockwise
Trig Amp X1	Pushed in
50 Ω 2 V Max	Pushed in

Type S-54

Lead Time Fully CCW

b. Connect the PULSE OUTPUT through a BNC 50 Ω coaxial cable, and a BNC to GR adapter to the Type S-1. Connect the PRETRIG OUT through a BSM to BNC 50 Ω coaxial cable, and a BNC to 3 mm adapter to the 7T11 Trig Input. (Be sure a coaxial cable is connected to the Trigger Out connector on the Type 285 and terminated in 50 Ω .)

c. Advance the A intensity until a free-running trace is observed. Center the trace vertically on the CRT with the 7S11 DC Offset control.

d. Set the 7T11 Trigger Level control to obtain a stable display of the PULSE OUTPUT leading edge.

e. Set the 7S11 Variable for a 5 division amplitude at the rising portion. Use the DC Offset control to center the display vertically.

f. Set the 7T11 Time/Div to 200 ps, and set the Time Position control to position the PULSE OUTPUT leading edge to the center of the graticule. See Fig. 5-3.

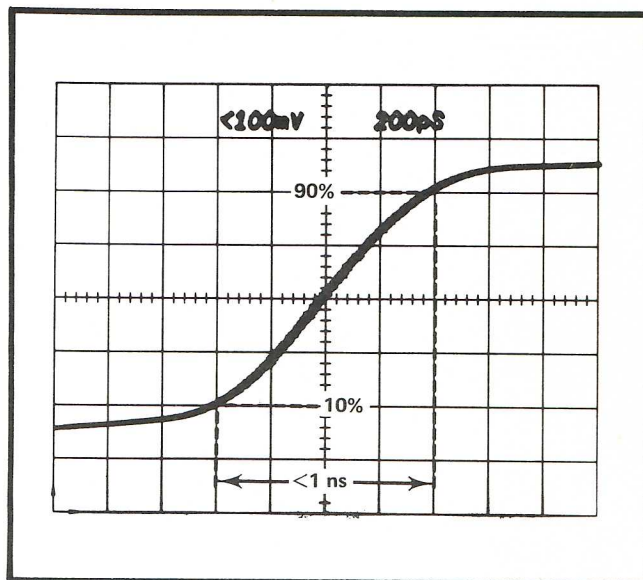

Fig. 5-3. PULSE OUTPUT risetime.

Performance Check/Calibration—S-54

g. Measure the risetime from the 10% to the 90% amplitude (center 4 divisions) to be 1 ns or less.

5. Check PULSE OUTPUT Aberrations

a. Change the 7T11 Time/Div to 1 ns.

b. Use the 7S11 DC Offset control to position the top of the PULSE OUTPUT (at the leading edge) to the center of the graticule, and change the mVolts/Div to 5 mV. This sets the amplitude at 1% per division (see Fig. 5-4).

c. Check that the aberrations are less than +1.5%, -1.5%, total of 1.5% P-P.

NOTE

Total aberrations shown in Fig. 5-4 combine the aberrations of the Sampling Oscilloscope, coaxial connectors, cables, and the Type S-54. The large aberration shown between the graticule line 6 and 7 is a result of a coaxial connector reflection.

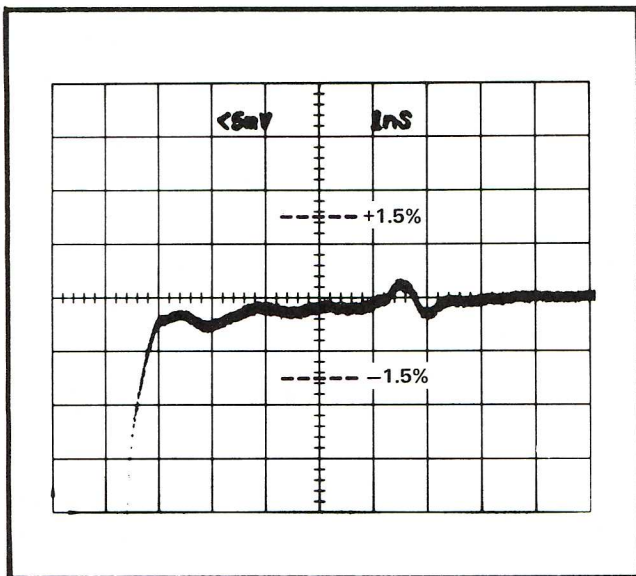

Fig. 5-4. PULSE OUTPUT aberrations.

6. Check PRETRIG OUT to PULSE OUTPUT jitter

a. Be sure that the Type S-54 LEAD TIME control is fully CCW. Change the 7S11 mVolts/Div control to 200, and vertically center the PULSE OUTPUT on the CRT.

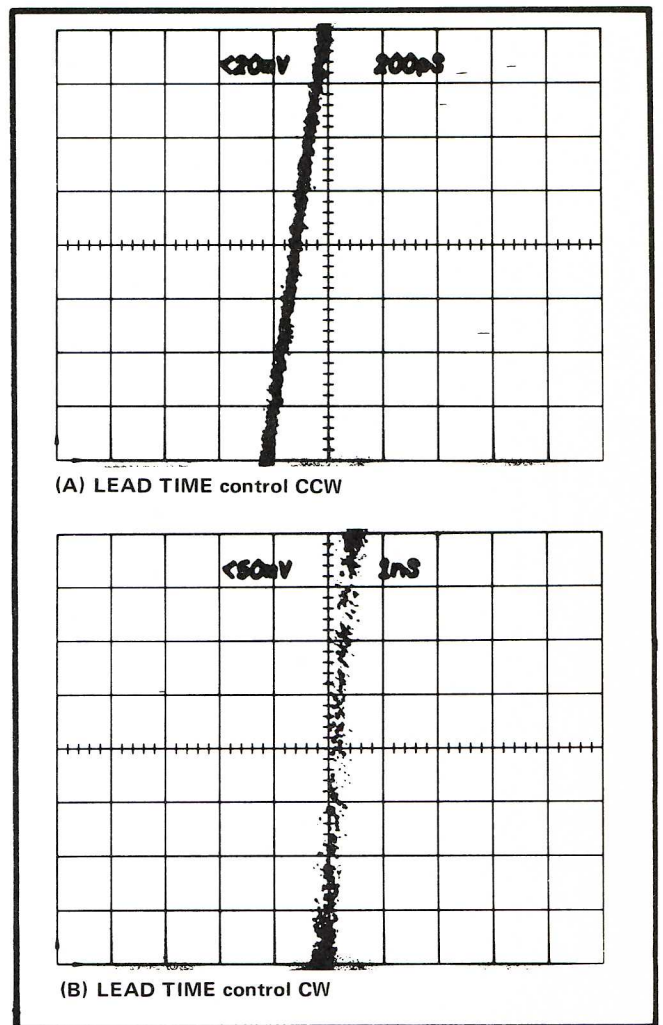

Fig. 5-5. Jitter check displays.

b. Change the 7T11 Time/Div to 200 ps and change the Time Position control to center the PULSE OUTPUT leading edge to the center of the graticule.

c. Change the 7S11 mVolts/Div to 20 and check the jitter to be less than 100 ps (see Fig. 5-5A).

NOTE

Total jitter shown in Fig. 5-5 combines the Sampling Oscilloscope jitter and the Type S-54 PRETRIG OUT to PULSE OUTPUT jitter. If the total combined jitter exceeds the S-54 performance requirements, it will be necessary to measure the Sampling Oscilloscope jitter to determine the net amount of S-54 jitter.

d. Change the following controls:

	Type S-54	
LEAD TIME		Set to 1 μ s
	7S11	
mVolts/Div		200
	7T11	
Sweep Range		5 μ s
Time/Div		200 ns
Time Position		Fully clockwise

e. Change the 7T11 Time/Div to 1 ns and change the Time Position control to position the PULSE OUTPUT LEADING edge at the center of the CRT.

f. Change the 7S11 mV/Div to 50 and check the jitter to be less than 1 ns (see Fig. 5-5B).

g. Disconnect all connections at the Oscilloscope.

7. Check PRETRIG OUT Amplitude and Risetime

a. Change the following controls:

	Type S-54	
LEAD TIME		Fully counterclockwise
	7S11	
Variable		Pushed in
mV/Div		100
	7T11	
Time Position and Fine		Fully clockwise
Random		Pushed in
Sweep Range		.5 μ s
Time/Div		10 ns

b. Connect the Type S-54 PRETRIG OUT through a BSM to BNC 50 Ω coaxial cable, and a BNC to GR adapter to the Type S-1. Connect the PULSE OUTPUT through a BNC 50 Ω coaxial cable, and a BNC to 3 mm adapter to the 7T11 Trig Input. (Be sure a coaxial cable is connected to the trigger Out connector on the Type 285, and is 50 Ω terminated.)

c. Set the 7T11 Trigger Level control to obtain a stable display of the PRETRIG OUT pulse.

d. Check that the amplitude is at least 200 mV.

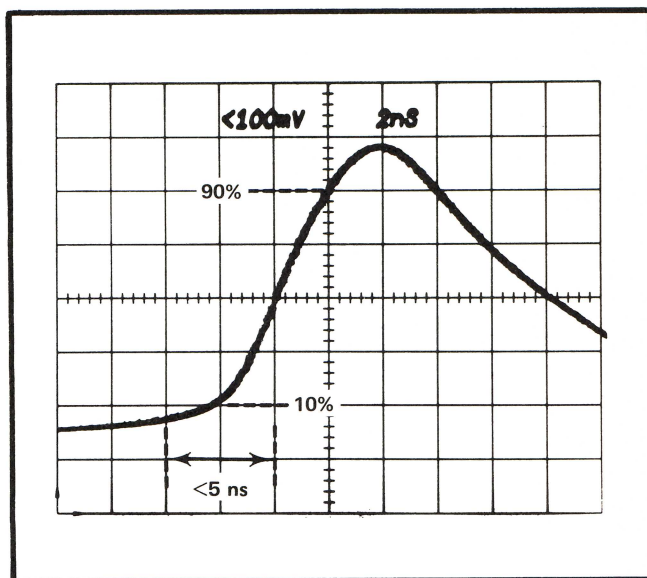

Fig. 5-6. PRETRIGGER OUT risetime.

e. Set the 7S11 Variable for a 5 division amplitude at the rising portion. Set the 7T11 Time/Div to 2 ns and use the 7T11 Time Position control and the 7S11 DC Offset control to center the pulse on the CRT. See Fig. 5-6.

f. Measure the risetime from the 10% to the 90% amplitude (center four divisions) to be 5 ns or less.

g. Change the 7S11 Variable to Cal In (pushed in) position.

8. Check Pretrigger Out (Rear Panel) Amplitude and Risetime

a. Disconnect the 50 Ω coaxial cable at the Type S-54 PRETRIG OUT connector.

b. Connect the Trigger Out 50 Ω connector on the Type 285 through a BSM to BNC 50 Ω coaxial cable and a BNC to GR adapter to the Type S-1.

c. Set the 7T11 Trigger Level control to obtain a stable display of the Pretrigger Out.

d. Check that the amplitude is at least 200 mV.

e. Set the 7S11 Variable for a 5 division amplitude at the rising portion. Use the 7T11 Time Position control and the 7S11 DC Offset control to center the pulse on the CRT.

f. Measure the risetime from the 10% to the 90% amplitude (center four divisions) to be 5 ns or less. Refer to Fig. 5-6.

CALIBRATION PROCEDURE

Introduction

The Calibration Procedure contains all the adjustments required in the instrument, and is arranged so that troubleshooting can be accomplished at the same time. Additional troubleshooting information is contained in the Maintenance Section and in the Diagrams Section.

Preliminary Procedure

The first four steps use the Test Oscilloscope equipment list (item 1) with a dual-channel amplifier and time base (7A12 and 7B50 of item 2), and Type 285 Power Supply (item 3). Step 5 uses the Test Oscilloscope (item 1), with a sampling amplifier and Time Base (7S11 with Type S-1 and 7T11 of item 2), and Type 285 Power Supply (item 3).

Three adjustments can be made without removing the Type S-54 from its case; Duration Trigger Level (R30) at the left side of the case; Q50 Bias (R50) at the upper right side of the case; C64 at the center right side of the case.

1. Install the Sampling-Head extender (item 9) into the Type 285 Power Supply.

2. Remove the Type S54 from its housing (see the Maintenance Section of the manual if necessary) and install it onto the Sampling Head extender.

3. Set the controls as follows:

7504 Indicator Oscilloscope

A Intensity	CCW
B Intensity	CCW
Vertical Mode	Left
Horizontal Mode	B
A Trigger Source	Right Vert
B Trigger Source	Left Vert

7A12

(Left vertical plug-in compartment)

Display Mode	ALT
Trigger Source	CH 1
	CH 1 & CH 2
Volts/Div	.1
Position	Midrange
Polarity	+Up
Variable	Cal In
Coupling	DC

7B50

(B horizontal plug-in compartment)

Level/Slope Triggered	Centered on Positive Slope
Mode	Auto
Coupling	AC
Source	Ext
Position	Midrange
Time/Div	.05 μ s
Display Mode	Time Base
Magnifier	X1

S-54

LEAD TIME	Fully Counterclockwise
-----------	------------------------

4. Turn on the Type 285 and the Oscilloscope power. After about a five minute warmup, advance the B intensity until a free-running trace is observed. Center the trace on the CRT with the horizontal and vertical position controls.

1. Adjust Duration Trigger Level (R30) ❶

a. Connect the Trigger Out connector on the Type 285 through a BSM to BNC 50 Ω coaxial cable, and a 50 Ω feedthrough termination to the 7B50 Ext Trig In. Connect the Type S-54 PRETRIG OUT through a BSM to BNC coaxial cable, and a 50 Ω feedthrough termination to the 7A12 CH 1 connector. Connect the 10X probe to the 7A12 CH 2, and connect the probe tip to the square pin test point or U30 B pin 8. See Fig. 5-7. Connect the probe ground lead to the Timing board ground.

b. Change the 7B50 Triggering Mode to Normal and set the Level/Slope for a stable display.

c. Adjust R30 fully clockwise, then slowly counterclockwise, until a stable rising portion of the Duration circuit output signal appears on channel 2. See Fig. 5-8.

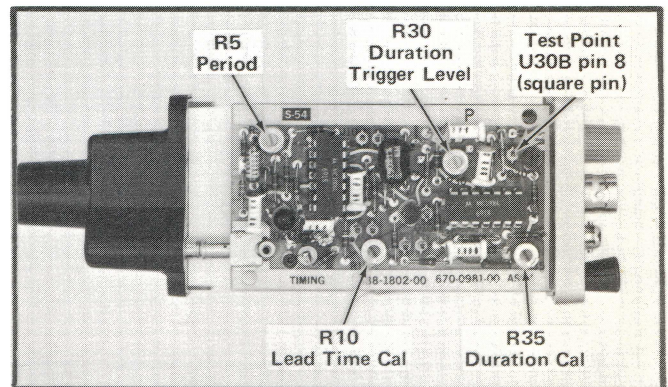

Fig. 5-7. Timing board, on the instrument left side, showing the location of internal controls.

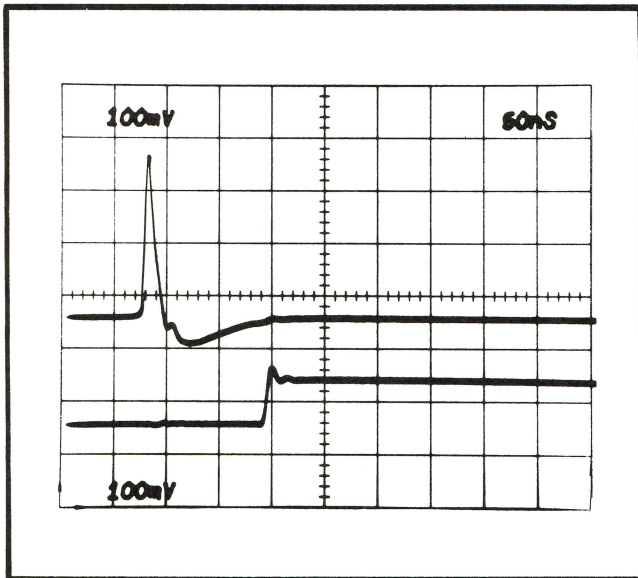

Fig. 5-8. Display to adjust Duration Trigger Level (R30).

2. Adjust Q50 Bias (R50) ①

a. Remove the 10X probe. Connect the Type S-54 PULSE OUTPUT through a BNC 50 Ω coaxial cable, and a 50 Ω feedthrough termination to the 7A12 CH 2 connector.

b. Adjust R50 (see Fig. 5-9), first fully clockwise, then slowly counterclockwise until the rising portion of the PULSE OUTPUT signal appears on channel 2. Note this position and continue to adjust R50 slowly counterclockwise until the rising portion of the PULSE OUTPUT signal disappears. Then set R50 midrange between the two positions. See Fig. 5-1A.

3. Adjust Lead Time Cal (R10) ①

a. Observe the minimum lead time between the PRE-TRIG OUT pulse on channel 1 and the PULSE OUTPUT signal on channel 2; see Fig. 5-1A.

b. Adjust R10 (see Fig. 5-6 for its location) for about 115 ns of lead time.

c. Change the 7B50 Time/Div to .2 μ s, and the Type S-54 LEAD TIME control to fully clockwise.

d. Check the lead time between the PRETRIG OUT pulse on channel 1 and the PULSE OUTPUT signal on channel 2 to be 1 μ s or greater (see Fig. 5-1B).

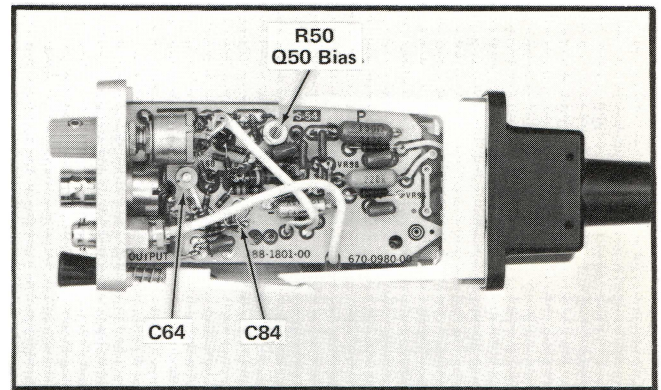

Fig. 5-9. Output board, on the instrument right side, showing the location of internal controls.

4. Adjust Period and Duration Cal (R5, R35) ①

a. Change the 7B50 Time/Div to 5 μ s.

b. Adjust R5 for one cycle (period) in 10 divisions. See Fig. 5-2.

c. Adjust R35 for 5 divisions of positive pulse (Duration). See Fig. 5-2.

d. Disconnect the connections at the Oscilloscope.

5. Adjust C64 and C84

a. Set the controls as follows:

7504 Indicator Oscilloscope

A Intensity	CCW
B Intensity	CCW
Vertical Mode	Right
Horizontal Mode	A
A Trigger Source	Right Vert
B Trigger Source	Left Vert

7S11 with Type S-1 Sampling Head (Right vertical plug-in compartment)

Delay	Midrange
+Up	Pushed In
DC Offset ± 1 V and Fine	Midrange
mVolts/Div	100
Variable	Pushed In
Dot Response	Midrange
Normal	Pushed In

7T11
(A horizontal plug-in compartment)

Time Position and Fine	Fully clockwise
Sequential	Pushed In
Sweep Range	50 ns
Time/Div	5 ns
Variable	Pushed in
Scan	Midrange
Rep	Pushed in
Slope +	Pushed in
Trig Level	Midrange
Stability	Fully clockwise
Trig Amp X1	Pushed in
50 Ω 2 V Max	Pushed in

b. Advance the A intensity until a trace is observed. Set the 7T11 Trigger Level control to obtain a stable display of the PULSE OUTPUT leading edge.

c. Set the 7S11 DC Offset control to vertically center the display. Set the 7T11 Time/Div to 500 ps, and change

the Time Position control to center the leading edge of the PULSE OUTPUT on the CRT.

d. Adjust C64 (see Fig. 5-9) for fast risetime without overshoot. No further adjustment is required for C64 or C84 if the risetime (10 to 90% amplitude) is 1 ns or less and the aberrations (less than +1.5%, -1.5%, total of 1.5% P-P of amplitude) are within the specifications. Normally C64, when misadjusted, will show a slight overshoot and faster risetime. If no effect is noticed with the adjustment of C64, or the pulse overshoot cannot be reduced, an improvement may be possible with a change in the capacitance of the wire capacitor (twisted pair of wires) C84.

NOTE

Two wires of No. 32 AWG size are twisted together 2 inches long and cut to length for the proper capacitance across R84. Increasing the coupling between the two wires forming C84 will increase the capacitance. Care should be taken to keep the wires away from metal parts.

PARTS LIST ABBREVIATIONS

BHB	binding head brass	int	internal
BHS	binding head steel	lg	length or long
cap.	capacitor	met.	metal
cer	ceramic	mtg hdw	mounting hardware
comp	composition	OD	outside diameter
conn	connector	OHB	oval head brass
CRT	cathode-ray tube	OHS	oval head steel
csk	countersunk	P/O	part of
DE	double end	PHB	pan head brass
dia	diameter	PHS	pan head steel
div	division	plstc	plastic
elect.	electrolytic	PMC	paper, metal cased
EMC	electrolytic, metal cased	poly	polystyrene
EMT	electrolytic, metal tubular	prec	precision
ext	external	PT	paper, tubular
F & I	focus and intensity	PTM	paper or plastic, tubular, molded
FHB	flat head brass	RHB	round head brass
FHS	flat head steel	RHS	round head steel
Fil HB	fillister head brass	SE	single end
Fil HS	fillister head steel	SN or S/N	serial number
h	height or high	S or SW	switch
hex.	hexagonal	TC	temperature compensated
HHB	hex head brass	THB	truss head brass
HHS	hex head steel	thk	thick
HSB	hex socket brass	THS	truss head steel
HSS	hex socket steel	tub.	tubular
ID	inside diameter	var	variable
inc	incandescent	w	wide or width
		WW	wire-wound

PARTS ORDERING INFORMATION

Replacement parts are available from or through your local Tektronix, Inc. Field Office or representative.

Changes to Tektronix instruments are sometimes made to accommodate improved components as they become available, and to give you the benefit of the latest circuit improvements developed in our engineering department. It is therefore important, when ordering parts, to include the following information in your order: Part number, instrument type or number, serial or model number, and modification number if applicable.

If a part you have ordered has been replaced with a new or improved part, your local Tektronix, Inc. Field Office or representative will contact you concerning any change in part number.

SPECIAL NOTES AND SYMBOLS

×000	Part first added at this serial number
00×	Part removed after this serial number
*000-0000-00	Asterisk preceding Tektronix Part Number indicates manufactured by or for Tektronix, Inc., or reworked or checked components.
Use 000-0000-00	Part number indicated is direct replacement.

INDEX OF ELECTRICAL PARTS LIST

Title	Page No.
Chassis	6-1
A1 TIMING Circuit Board Assembly	6-1
A2 OUTPUT Circuit Board Assembly	6-3

SECTION 6

ELECTRICAL PARTS LIST

Values are fixed unless marked Variable.

Ckt. No.	Tektronix Part No.	Serial/Model No. Eff	Disc	Description
----------	-----------------------	-------------------------	------	-------------

CHASSIS

Resistor

Resistors are fixed, composition, $\pm 10\%$ unless otherwise indicated.

R15	311-0580-00		50 k Ω , Var
-----	-------------	--	---------------------

Connector

J80	131-1004-00		Receptacle, electrical, BNC, female
-----	-------------	--	-------------------------------------

A1 TIMING Circuit Board Assembly

*670-0981-00

Complete Board

Capacitors

Tolerance $\pm 20\%$ unless otherwise indicated.

C7	285-0901-00	0.047 μ F	PTM	50 V	5%
C10	281-0656-00	22 pF	Cer	200 V	5%
C12	283-0644-00	150 pF	Mica	500 V	1%
C14	281-0638-00	240 pF	Cer	500 V	5%
C18	281-0528-00	82 pF	Cer	500 V	10%
C22	281-0638-00	240 pF	Cer	500 V	5%
C24	283-0122-00	270 pF	Cer	500 V	5%
C26	281-0523-00	100 pF	Cer	350 V	
C30	285-0901-00	0.047 μ F	PTM	50 V	5%
C35	283-0111-00	0.1 μ F	Cer	50 V	
C36	281-0523-00	100 pF	Cer	350 V	

Semiconductor Device, Diodes

CR10	*152-0233-00	Silicon	Tek Spec	
CR12	152-0141-02	Silicon	1N4152	
CR20	*152-0322-00	Silicon	Tek Spec	
CR30	152-0141-02	Silicon	1N4152	
CR26	*152-0499-00	Silicon	Snap-off, Tek made	

A1 TIMING Circuit Board Assembly (cont)

Ckt. No.	Tektronix Part No.	Serial/Model No. Eff	Disc	Description
Connectors				
J18 P20	*175-1259-00 131-0409-01			Cable assembly Connector, Cannon Series #DM53743-5001
Transistors				
Q10	151-0221-00		Silicon	PNP TO-18 2N4258
Q20	*151-0269-00		Silicon	NPN TO-106 Selected from SE3005
Q30	151-0221-00		Silicon	PNP TO-18 2N4258
Resistors				
Resistors are fixed, composition, $\pm 10\%$ unless otherwise indicated.				
R5	311-0978-00		250 Ω , Var	
R6	317-0621-00		620 Ω	$\frac{1}{8}$ W 5%
R7	317-0152-00		1.5 k Ω	$\frac{1}{8}$ W 5%
R8	317-0152-00		1.5 k Ω	$\frac{1}{8}$ W 5%
R9	317-0362-00		3.6 k Ω	$\frac{1}{8}$ W 5%
R10	311-0635-00		1 k Ω , Var	
R11	317-0392-00		3.9 k Ω	$\frac{1}{8}$ W 5%
R12	317-0152-00		1.5 k Ω	$\frac{1}{8}$ W 5%
R13	317-0222-00		2.2 k Ω	$\frac{1}{8}$ W 5%
R14	317-0102-00		1 k Ω	$\frac{1}{8}$ W 5%
R16	317-0152-00		1.5 k Ω	$\frac{1}{8}$ W 5%
R18	317-0241-00		240 Ω	$\frac{1}{8}$ W 5%
R20	317-0103-00		10 k Ω	$\frac{1}{8}$ W 5%
R22	317-0512-00		5.1 k Ω	$\frac{1}{8}$ W 5%
R24	317-0331-00		330 Ω	$\frac{1}{8}$ W 5%
R27	317-0102-00		1 k Ω	$\frac{1}{8}$ W 5%
R28	317-0392-00		3.9 k Ω	$\frac{1}{8}$ W 5%
R29	317-0152-00		1.5 k Ω	$\frac{1}{8}$ W 5%
R30	311-0978-00		250 Ω , Var	
R31	317-0152-00		1.5 k Ω	$\frac{1}{8}$ W 5%
R32	317-0241-00		240 Ω	$\frac{1}{8}$ W 5%
R33	317-0151-00		150 Ω	$\frac{1}{8}$ W 5%
R34	317-0362-00		3.6 k Ω	$\frac{1}{8}$ W 5%
R35	311-0635-00		1 k Ω , Var	
R36	317-0102-00		1 k Ω	$\frac{1}{8}$ W 5%
R39	317-0152-00		1.5 k Ω	$\frac{1}{8}$ W 5%

A1 TIMING Circuit Board Assembly (cont)

Ckt. No.	Tektronix Part No.	Serial/Model No. Eff	Disc	Description
Transformers				
T15	*120-0318-00			Toroid, 6 turns, bifilar
T18	*120-0318-00			Toroid, 6 turns, bifilar
T20	*120-0318-00			Toroid, 6 turns, bifilar
Integrated Circuits				
U10	156-0054-00			Dual 4 input clock driver. Replaceable by Motorola MC1006L
U30	156-0054-00			Dual 4 input clock driver. Replaceable by Motorola MC1006L

A2 OUTPUT Circuit Board Assembly

*670-0980-00

Complete Board

Capacitors

Tolerance $\pm 20\%$ unless otherwise indicated.

C53	283-0196-00	270 pF	Cer	50 V	10%
C55	283-0073-00	0.0022 μ F	Cer	200 V	5%
C56	283-0177-00	1 μ F	Cer	25 V	+80%—20%
C60	283-0111-00	0.1 μ F	Cer	50 V	
C64	281-0122-00	2.5-9 pF, Var	Cer	100 V	
C74	290-0167-00	10 μ F	Elect.	15 V	
C75	283-0073-00	0.0022 μ F	Cer	200 V	5%
C83	283-0073-00	0.0022 μ F	Cer	200 V	5%
C84 ¹	Selected				
C86	283-0177-00	1 μ F	Cer	25 V	+80%—20%
C96	283-0177-00	1 μ F	Cer	25 V	+80%—20%
C97	283-0111-00	0.1 μ F	Cer	50 V	
C98	283-0177-00	1 μ F	Cer	25 V	+80%—20%

Semiconductor Device, Diodes

CR74	152-0141-02	Silicon	1N4152
CR76	152-0141-02	Silicon	1N4152
CR78	152-0141-02	Silicon	1N4152
CR80	*152-0458-01	Silicon	Schottky Barrier, Tek made
CR82	*152-0458-01	Silicon	Schottky Barrier, Tek made
CR84	*152-0458-01	Silicon	Schottky Barrier, Tek made
VR96	152-0279-00	Zener	1N751A 400 mW, 5.1 V, 5%
VR98	152-0279-00	Zener	1N751A 400 mW, 5.1 V, 5%

¹175-1242-00 CABLE ASSEMBLY, twisted wire pair. See Calibration Procedure.

A2 OUTPUT Circuit Board Assembly (cont)

Ckt. No.	Tektronix Part No.	Serial/Model No. Eff	Disc	Description
Transistors				
Q40	*151-0271-00		Silicon	PNP TO-18 Tek Spec
Q50	*151-0271-00		Silicon	PNP TO-18 Tek Spec
Q60	*151-0269-00		Silicon	NPN TO-106 Selected from SE3005
Q70	*151-0269-00		Silicon	NPN TO-106 Selected from SE3005
Q80	151-0212-00		Silicon	NPN TO-18 Tek Spec

Resistors

Resistors are fixed, composition, $\pm 10\%$ unless otherwise indicated.

R40	301-0122-00		1.2 k Ω	$\frac{1}{2}$ W		5%
R42	315-0510-00		51 Ω	$\frac{1}{4}$ W		5%
R45	317-0151-00		150 Ω	$\frac{1}{8}$ W		5%
R50	311-0635-00		1 k Ω , Var			
R52	317-0361-00		360 Ω	$\frac{1}{8}$ W		5%
R53	317-0470-00		47 Ω	$\frac{1}{8}$ W		5%
R54	317-0202-00		2 k Ω	$\frac{1}{8}$ W		5%
R55	317-0151-00		150 Ω	$\frac{1}{8}$ W		5%
R56	315-0821-00		820 Ω	$\frac{1}{4}$ W		5%
R60	301-0241-00		240 Ω	$\frac{1}{2}$ W		5%
R61	317-0047-00		4.7 Ω	$\frac{1}{8}$ W		5%
R62	317-0200-00		20 Ω	$\frac{1}{8}$ W		5%
R64	317-0300-00		30 Ω	$\frac{1}{8}$ W		5%
R71	317-0047-00		4.7 Ω	$\frac{1}{8}$ W		5%
R72	317-0200-00		20 Ω	$\frac{1}{8}$ W		5%
R74	315-0330-00		33 Ω	$\frac{1}{4}$ W		5%
R75	315-0512-00		5.1 k Ω	$\frac{1}{4}$ W		5%
R81	317-0201-00		200 Ω	$\frac{1}{8}$ W		5%
R82	317-0200-00		20 Ω	$\frac{1}{8}$ W		5%
R83	301-0751-00		750 Ω	$\frac{1}{2}$ W		5%
R84	317-0511-00		510 Ω	$\frac{1}{8}$ W		5%
R86	317-0562-00		5.6 k Ω	$\frac{1}{8}$ W		5%
R87	315-0111-00		110 Ω	$\frac{1}{4}$ W		5%
R88	315-0111-00		110 Ω	$\frac{1}{4}$ W		5%
R96	308-0231-00		220 Ω	3 W	WW	5%
R98	308-0218-00		150 Ω	3 W	WW	5%

SECTION 7

DIAGRAMS AND CIRCUIT BOARD ILLUSTRATIONS

Symbols and Reference Designators

Electrical components shown on the diagrams are in the following units unless noted otherwise:

Capacitors =	Values one or greater are in picofarads (pF).
	Values less than one are in microfarads (μ F).
Resistors =	Ohms (Ω)

Symbols used on the diagrams are based on USA Standard Y32.2-1967.

Logic symbology is based on MIL-STD-806B in terms of positive logic. Logic symbols depict the logic function performed and may differ from the manufacturer's data.

The following special symbols are used on the diagrams:

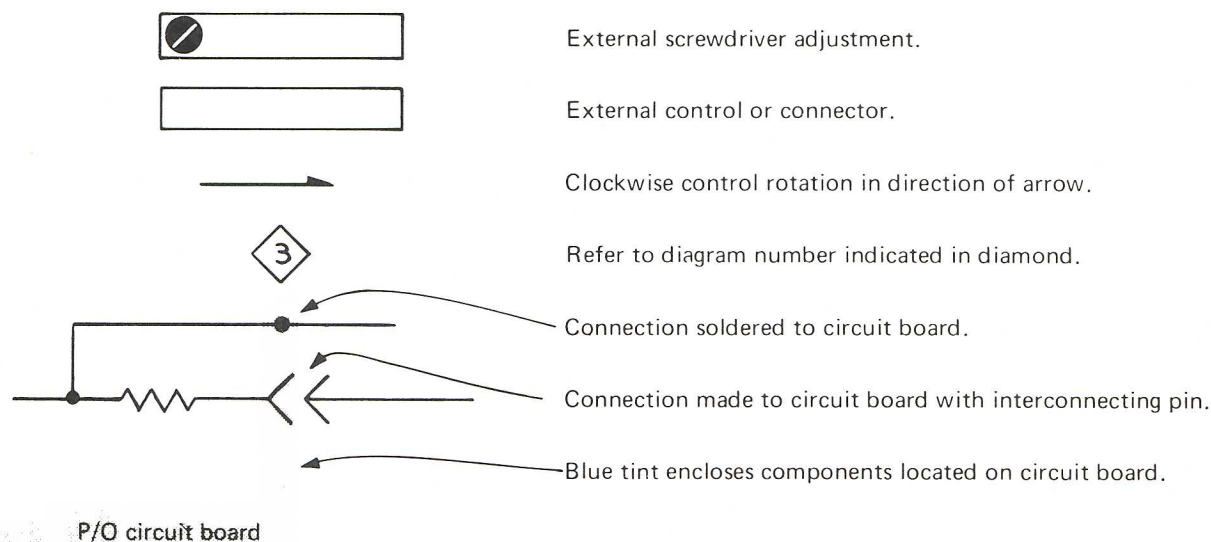

The following prefix letters are used as reference designators to identify components or assemblies on the diagrams.

A	Assembly, separable or repairable (circuit board, etc.)	LR	Inductor/resistor combination
AT	Attenuator, fixed or variable	M	Meter
B	Motor	Q	Transistor or silicon-controlled rectifier
BT	Battery	P	Connector, movable portion
C	Capacitor, fixed or variable	R	Resistor, fixed or variable
CR	Diode, signal or rectifier	RT	Thermistor
DL	Delay line	S	Switch
DS	Indicating device (lamp)	T	Transformer
F	Fuse	TP	Test point
FL	Filter	U	Assembly, inseparable or non-repairable (integrated circuit, etc.)
H	Heat dissipating device (heat sink, heat radiator, etc.)	V	Electron tube
HR	Heater	VR	Voltage regulator (zener diode, etc.)
J	Connector, stationary portion	Y	Crystal
K	Relay		
L	Inductor, fixed or variable		

LOCATIONS

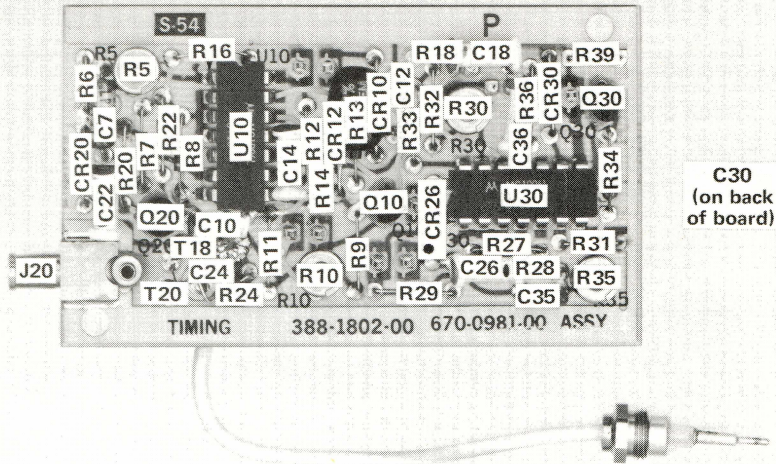

Timing Circuit Board A-1 Component Locations

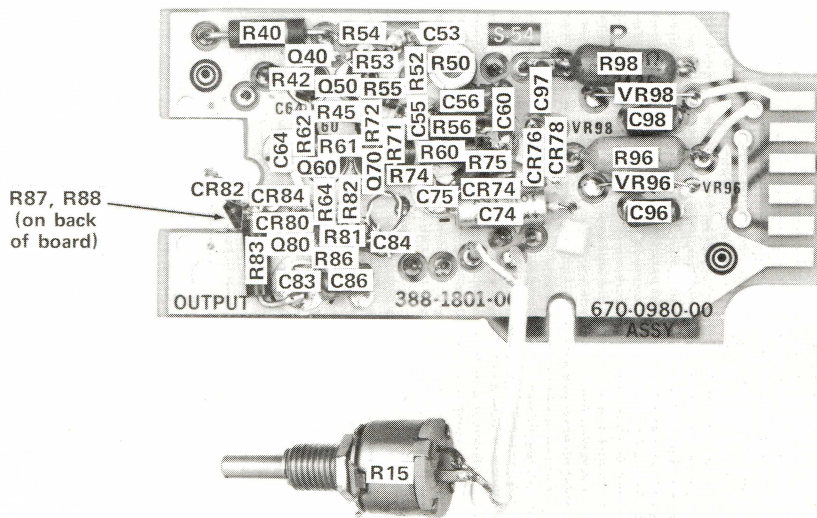

Output Circuit Board A-2 Component Locations

Troubleshooting Conditions

Power is obtained from Type 285 Sampling Head Power Supply or Sampling Head compartment. Use a sampling Head Extender so that the Type S-54 outside case can be removed. Trigger the Test oscilloscope from the Pretrigger Out. Leave PULSE OUTPUT 50 Ω Terminated while checking other waveforms.

Test Points

1

2

3

4

5

6

7

8

9

10

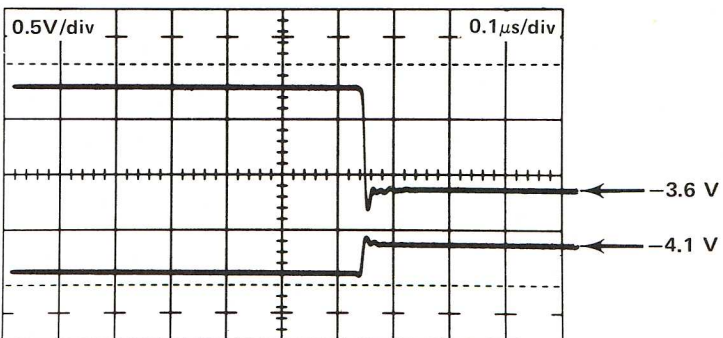
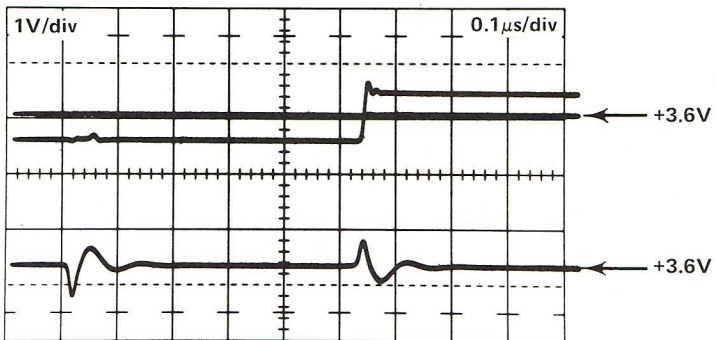
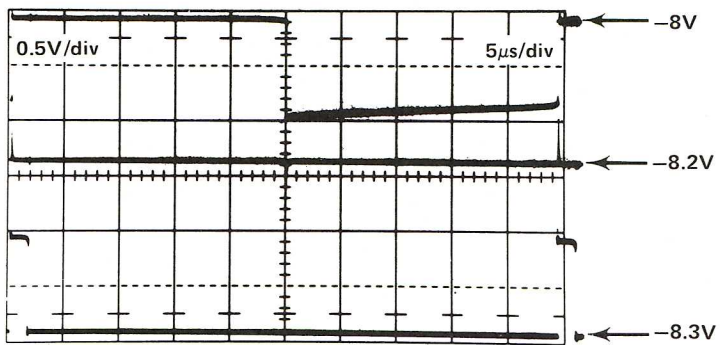
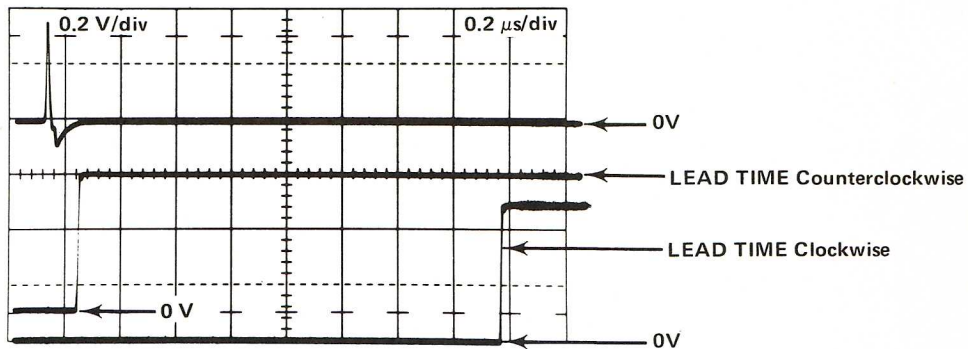

(A)

Troubleshooting waveforms were obtained with a Type 547 and Type 1A1. Signals for waveforms 1 & 2 were coaxial connected and 50 Ω terminated, and all others were connected with a 10X probe and a short probe ground lead. DC coupling was used for waveforms 6 & 7.

FIGURE AND INDEX NUMBERS

Items in this section are referenced by figure and index numbers to the illustrations which appear either on the back of the diagrams or on pullout pages immediately following the diagrams of the instruction manual.

INDENTATION SYSTEM

This mechanical parts list is indented to indicated item relationships. Following is an example of the indentation system used in the Description column.

Assembly and/or Component
Detail Part of Assembly and/or Component
mounting hardware for Detail Part
Parts of Detail Part
mounting hardware for Parts of Detail Part
mounting hardware for Assembly and/or Component

Mounting hardware always appears in the same indentation as the item it mounts, while the detail parts are indented to the right. Indented items are part of, and included with, the next higher indentation.

Mounting hardware must be purchased separately, unless otherwise specified.

PARTS ORDERING INFORMATION

Replacement parts are available from or through your local Tektronix, Inc. Field Office or representative.

Changes to Tektronix instruments are sometimes made to accommodate improved components as they become available, and to give you the benefit of the latest circuit improvements developed in our engineering department. It is therefore important, when ordering parts, to include the following information in your order: Part number, instrument type or number, serial or model number, and modification number if applicable.

If a part you have ordered has been replaced with a new or improved part, your local Tektronix, Inc. Field Office or representative will contact you concerning any change in part number.

Change information, if any, is located at the rear of this manual.

ABBREVIATIONS AND SYMBOLS

For an explanation of the abbreviations and symbols used in this section, please refer to the page immediately preceding the Electrical Parts List in this instruction manual.

SECTION 8

MECHANICAL PARTS LIST

FIGURE 1 EXPLODED

Fig. & Index No.	Tektronix Part No.	Serial/Model No. Eff	No. Disc	Q † Y	Description	Q				
						1	2	3	4	5
1-1	333-1373-00			1	PANEL, front					
	- - - - -			-	mounting hardware: <i>(not included w/panel)</i>					
-2	211-0069-00			1	SCREW, 2-56 x 0.125 inch, PHS					
	-3 386-1338-13			1	SUBPANEL, front					
	-4 670-0980-00			1	CIRCUIT BOARD ASSEMBLY—OUTPUT A2					
	- - - - -			-	circuit board assembly includes:					
	388-1801-00			1	CIRCUIT BOARD					
-5	352-0228-00			1	HOLDER, cable, plastic					
-6	131-0591-00			8	TERMINAL, pin, 0.835 inch long					
-7	214-1081-00			2	PIN, spiral					
	- - - - -			-	mounting hardware: <i>(not included w/circuit board assembly)</i>					
-8	211-0162-00			2	SCREW, 2-56 x 0.188 inch, CHS					
	-9 131-1004-00			1	CONNECTOR, receptacle, electrical, BNC, female					
	- - - - -			-	mounting hardware: <i>(not included w/connector)</i>					
-10	352-0178-01			1	HOLDER, connector					
-11	220-0545-00			1	NUT, retaining, BNC					
	-12 384-0687-00			1	SHAFT, extension, latch					
-13	214-1226-01			1	SPRING, helical, compression					
-14	105-0066-00			1	STRIKE, latch, plastic					
-15	175-1259-00			1	CABLE ASSEMBLY, electrical, w/connector					
-16	366-1023-00			1	KNOB, gray					
	- - - - -			-	knob includes:					
	213-0153-00			1	SETSCREW, 5-40 x 0.125 inch, HSS					
-17	- - - - -			1	RESISTOR, variable					
	- - - - -			-	mounting hardware: <i>(not included w/resistor)</i>					
-18	210-0046-00			1	WASHER, lock, internal, 0.261 ID x 0.40 inch OD					
-19	210-0562-00			2	NUT, hex., 0.25-40 x 0.312 inch					
	-20 670-0981-00			1	CIRCUIT BOARD ASSEMBLY—TIMING A1					
	- - - - -			-	circuit board assembly includes:					
	388-1802-00			1	CIRCUIT BOARD					
-21	136-0350-00			3	SOCKET, transistor, 3 pin					
-22	136-0263-00			8	SOCKET, pin terminal					
-23	131-0409-01			1	CONNECTOR, receptacle, w/holder					
-24	380-0229-00			1	HOUSING, sampling head					
	- - - - -			-	housing includes:					
-25	131-0555-00			2	CONTACT, electrical					
-26	386-1337-14			1	PANEL, rear					
	- - - - -			-	mounting hardware: <i>(not included w/panel)</i>					
-27	211-0141-00			4	SCREW, 4-40 x 3.25 inch, PHS					

STANDARD ACCESSORIES

012-0118-00	1	CABLE ASSEMBLY, RF, 50 Ω , coaxial
103-0030-00	1	ADAPTER, BNC T male to 2 female
070-1093-00	1	MANUAL, instruction

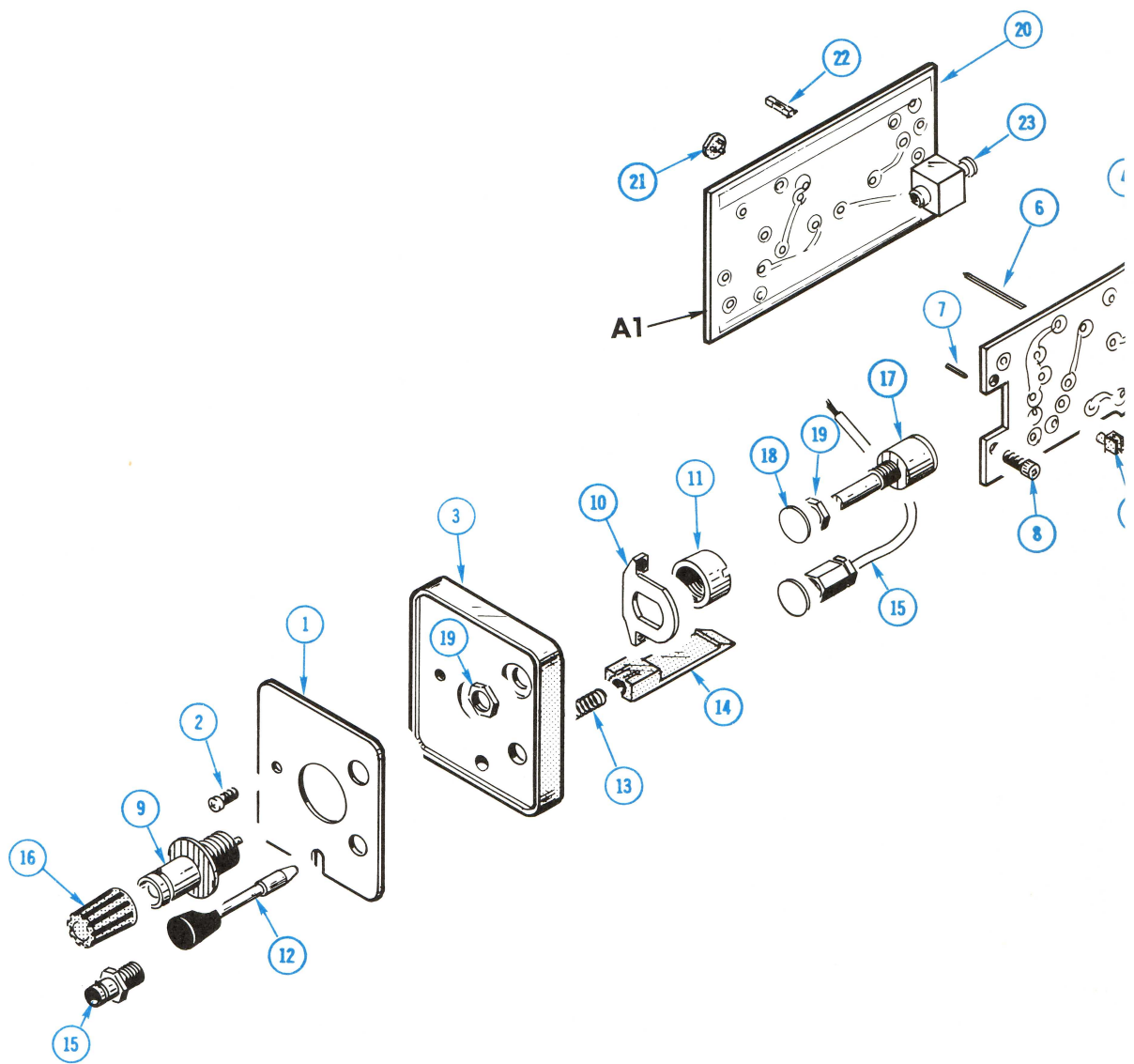

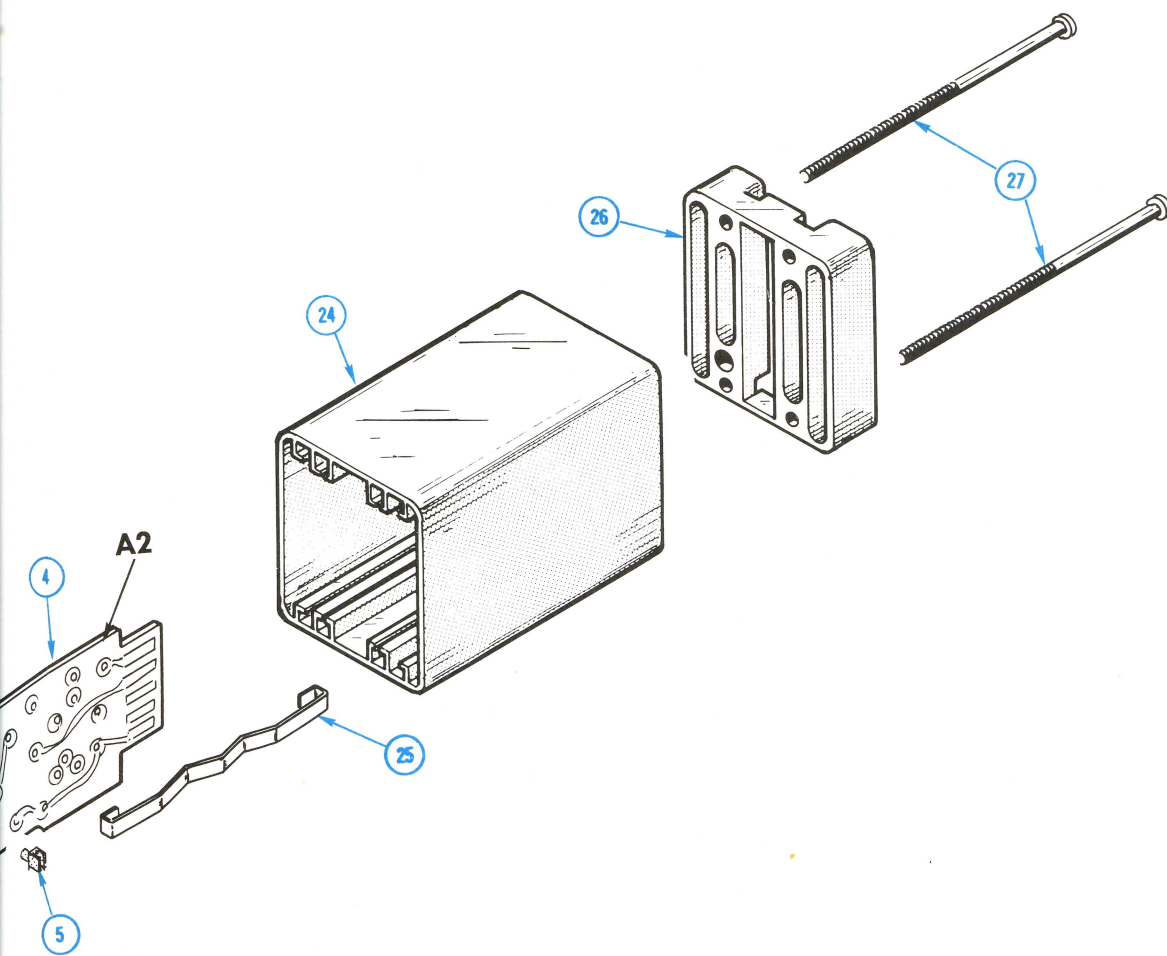

FIG. 1 EXPLODED

TYPE S-54

MANUAL CHANGE INFORMATION

At Tektronix, we continually strive to keep up with latest electronic developments by adding circuit and component improvements to our instruments as soon as they are developed and tested.

Sometimes, due to printing and shipping requirements, we can't get these changes immediately into printed manuals. Hence, your manual may contain new change information on following pages.

A single change may affect several sections. Sections of the manual are often printed at different times, so some of the information on the change pages may already be in your manual. Since the change information sheets are carried in the manual until ALL changes are permanently entered, some duplication may occur. If no such change pages appear in this section, your manual is correct as printed.

ELECTRICAL PARTS LIST AND SCHEMATIC CORRECTION

A2 OUTPUT Circuit Board Assembly

CHANGE TO:

R56	315-0621-00	620 Ω	1/4 W	5%
R60	301-0201-00	200 Ω	1/2 W	5%